



reisenrthel®

20  
23

# VISIONARY & EXCEPTIONAL

reisenthel ist innovativ und bleibt sich gleichzeitig treu. Wir verbinden Designkompetenz mit Funktionalität, Qualität und Nachhaltigkeit. Wir sind am Puls der Zeit und denken in die Zukunft. Wir mögen es klassisch – lieben aber auch Trends, greifen diese auf und setzen sie ergänzend zu unserem Basic-Portfolio in angesagten Dekoren, stylischen Shapes und neuen Stoffen um. Modern, nachhaltig, langlebig: Von reisenthel Taschen und Accessoires kann man einfach nicht genug haben!

*reisenthel is innovative and at the same time remains true to itself. We combine design competence with functionality, quality and sustainability. We have our finger on the pulse of the times and think ahead to the future. We like classics, but we also love trends – we pick them up and implement them in stylish decors, stylish shapes and new fabrics to complement our basic portfolio. Modern, sustainable, durable: you simply can't have enough reisenthel bags and accessories!*

*reisenthel innove tout en restant fidèle à son image. Nous associons compétence en matière de design, fonctionnalité, qualité et durabilité. Nous sommes dans l'air du temps et pensons à l'avenir. Nous aimons le classique, mais aussi les tendances – nous les saisissons et les mettons en œuvre en complément de notre portfolio de base dans des décors en vogue, des formes stylées et de nouveaux tissus. Modernes, durables, résistants : on ne se lasse pas des sacs et accessoires reisenthel !*







100%  
Recycled\*

\* Bis Ende 2023 wird unsere komplette Kollektion aus 100% recycelten Obermaterialien hergestellt.  
By the end of 2023, our entire collection will feature 100% recycled outer material.  
D'ici fin 2023, toute notre collection sera fabriquée à partir de matériaux 100% recyclés.



## MISSION COMPLETED!

Nachhaltigkeit ist kein Ergebnis. Sie ist ein Prozess mit klaren Zielsetzungen. Und reisenhel hat einen Meilenstein erreicht. Langlebig waren unsere Taschen schon immer. Das war uns jedoch nicht genug. Seit 2021 verwenden wir für alle reisenhel Neuheiten recycelte PET-Flaschen für das Obermaterial. Und bis Ende 2023 wird unsere komplette Kollektion aus 100% recycelten Obermaterialien hergestellt. Die Produktion läuft. Mission erfolgreich umgesetzt! Und wir planen bereits die nächsten Schritte. Werden Sie Teil unserer Nachhaltigkeits-Mission durch den Kauf von reisenhel Produkten!

*Sustainability is not a result. It is a process with clear objectives. And reisenhel has reached a milestone. Our bags have always been durable, but that was not enough for us. Since 2021, we have been using recycled PET bottles for the outer material of all reisenhel novelties. And by the end of 2023, our entire collection will feature 100% recycled outer material. Production is underway. Mission successfully accomplished! And we are already planning the next steps. Become part of our sustainability mission by buying reisenhel products!*

*La durabilité n'est pas un résultat. C'est un processus avec des objectifs clairs. Et reisenhel a atteint une étape importante. Nos sacs ont toujours eu une longue durée de vie. Mais cela ne nous suffisait pas. Depuis 2021, nous utilisons des bouteilles en PET recyclées comme matière principale principale de toutes les nouveautés reisenhel. Et d'ici fin 2023, la matière principale de toute notre collection sera fabriquée à partir de matériaux 100% recyclés. La production est en cours. Mission accomplie avec succès ! Et nous planifions déjà les prochaines étapes. Participez à notre mission de durabilité en achetant des produits reisenhel !*





**RHOMBUS**  
**MIDNIGHT**  
**GOLD**



**ALLROUNDER L**



**SADDLE BAG M**



**ALLROUNDER CROSS**



**ALLROUNDER R**



**ALLROUNDER M**



CARRYBAG



LOOPSHOPPER L FRAME



CLASSIC SHOPPER L



CLASSIC BACKPACK M



CLASSIC SHOPPER XL



CLASSIC SHOPPER M



TRAVELCOSMETIC



CARRYCRUISER FRAME



**PAISLEY**  
**BLACK**



LOOPSHOPPER L FRAME



CARRYBAG FRAME



ALLROUNDER M & L



ALLROUNDER R



TOILETBAG XL & TOILETBAG





ALLROUNDER CROSS



TROLLEY M FRAME



SHOPPER XL



SHOPPER M



ALLROUNDER S POCKET



SHOPPER E1



CARRYCRUISER FRAME



TRAVELCOSMETIC



CASE 1



GERMAN  
DESIGN  
AWARD  
WINNER  
2023



CARRYBAG FRAME



LOOPSHOPPER L FRAME



THERMOSHOPPER



LOOPSHOPPER M FRAME



ALLROUNDER L



COOLERBAG



SHOPPER XL



ALLROUNDER CROSS



ALLROUNDER R



ALLROUNDER M



TWIST  
SKY  
ROSE



TRAVELCOSMETIC



SHOPPER M



CARRYCRUISER FRAME



ALLDAY BACKBACK M



SHOPPER E1



HERRINGBONE  
DARK BLUE



ALLROUNDER R



TRAVELCOSMETIC



SHOPPER M



ROLLTOP BACKPACK



ALLROUNDER M & L





CARRYBAG

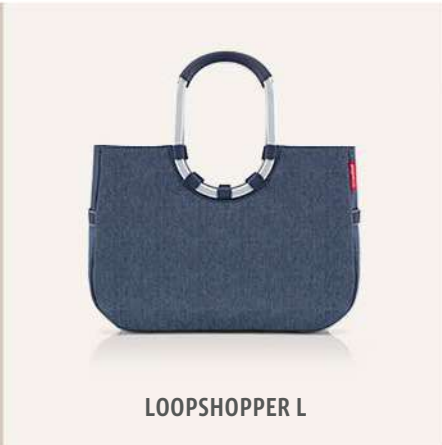

LOOPSHOPPER L



ALLROUNDER CROSS



CARRYCRUISER



OVERNIGHTER PLUS



SHOPPER E1



COOLERBAG



TOILETBAG XL & TOILETBAG



SHOPPER XL



# 2023 NEW COLLECTION

## DELIVERY DATES



ALLROUNDER CROSS DOTS  
LINE EXTENSION



OP-ART



RHOMBUS GINGER



RHOMBUS BLACK  
LINE EXTENSION



PAISLEY BLACK



LIMITED EDITION

PINEAPPLE

DEC  
22

JAN  
23

FEB  
23

MAR  
23

APR  
23

RHOMBUS  
MIDNIGHT GOLD



GARDEN BLUE



NOTEBOOK BAG / NOTEBOOK SLEEVE



NEW



NEW

GARDEN WHITE /  
GARDEN TAUPE



LIMITED EDITION

ROLLTOP BACKPACK / SADDLE BAG M



NEW



NEW



LIMITED EDITION



LIMITED EDITION

THERMO TWIST

SUMATRA



LIMITED EDITION

DAISY RED/  
DAISY BLUE



HERRINGBONE  
DARK BLUE



RHOMBUS  
OLIVE

MAY  
23

JUN  
23

JUL  
23

AUG  
23

SEP  
23

OCT  
23

SHOPPING BASKET

MINI MAXI SHOPPER  
DISPLAY #35 ANIMAL

DAHLIA BLUE/  
DAHLIA ROSE

MINI MAXI SHOPPER  
DISPLAY #36 BAROQUE MARBLE



COME  
BACK



LIMITED  
EDITION



LIMITED  
EDITION



LIMITED  
EDITION

LOOPSHOPPER M

CARRYBAG XS  
LINE EXTENSION

CARRYBAG  
FRAME  
CHROME



COME  
BACK



LIMITED  
EDITION





# SHOPPING

<b>CARRYBAG</b>	<b>18</b>	<b>SHOPPER XL</b>	<b>34</b>
CARRYBAG FRAME	20	CARRYCRUISER	36
<b>CARRYBAG XS</b>	<b>22</b>	<b>CARRYCRUISER PLUS</b>	<b>38</b>
LOOPSHOPPER M	23	CITYCRUISER RACK	40
<b>LOOPSHOPPER L</b>	<b>24</b>	<b>CITYCRUISER BAG</b>	<b>41</b>
EASYSHOPPINGBAG	26	TROLLEY M	42
<b>BOTTLEBAG</b>	<b>27</b>	<b>FOLDABLETROLLEY</b>	<b>43</b>
SHOULDERBAG S	28	SHOPPER-BACKBACK	44
<b>SHOPPINGBASKET</b>	<b>29</b>	<b>CLASSIC SHOPPER M</b>	<b>45</b>
SHOPPER M	30	CLASSIC SHOPPER L	46
<b>SHOPPER E1</b>	<b>32</b>	<b>CLASSIC SHOPPER XL</b>	<b>47</b>

# CARRYBAG®

**BEST  
SELLER**

reisen<sup>thel</sup>  
**ORIGINAL**



└ 48 x 29 x 28 cm  
□ 22 l

VE/UNIT 4/12

Design Award 2004  
**DESIGN PLUS**

□ Focus Know-how  
Silber 2005



DESIGNPREIS  
ZUR  
NACHHALTIGEN

• **Das Original – heiß begehrt, weltbekannt und schon heute ein Klassiker!**

- Stabiler Aluminiumrahmen
- Weich ummantelter Griff zum Umklappen
- 1 Innentasche mit Reißverschluss
- Fester Boden mit Standfüßen
- bavaria 5: mit hochwertiger Samtschleife
- rhombus black: modernes 3-D-Steppdesign
- Optionales Zubehör: carrybag cover
- Belastbar bis 20 kg
- Material: hochwertiges Polyestergewebe, wasserabweisend
- Recyceltes Obermaterial: 100 % hochwertiges recyceltes Polyestergewebe, wasserabweisend

• **The original: highly coveted, internationally known and already a classic today!**

- Sturdy aluminium frame
- Collapsible soft rubber handle
- 1 zip pocket inside
- Rigid bottom with base feet
- bavaria 5: with premium velvet bow
- rhombus black: modern 3-D quilted design
- Optional accessory: carrybag cover
- Loadable up to 20 kg
- Material: premium-quality polyester, water-repellent
- Recycled outer material: 100 % premium-quality recycled polyester, water-repellent

• **L'original : un modèle plébiscité et mondialement connu. Déjà un classique !**

- Cadre stable en aluminium
- Poignée rabattable avec revêtement souple
- 1 poche intérieure zippée
- Fond rigide avec pieds
- bavaria 5 : avec un nœud en velours de haute qualité
- rhombus black : motif matelassé moderne en 3D
- Accessoire en option : carrybag cover
- Résistant jusqu'à 20 kg
- Matière : polyester de haute qualité, déperlant
- Matière principale recyclée : 100 % polyester recyclée de haute qualité, déperlant

## CARRYBAG®

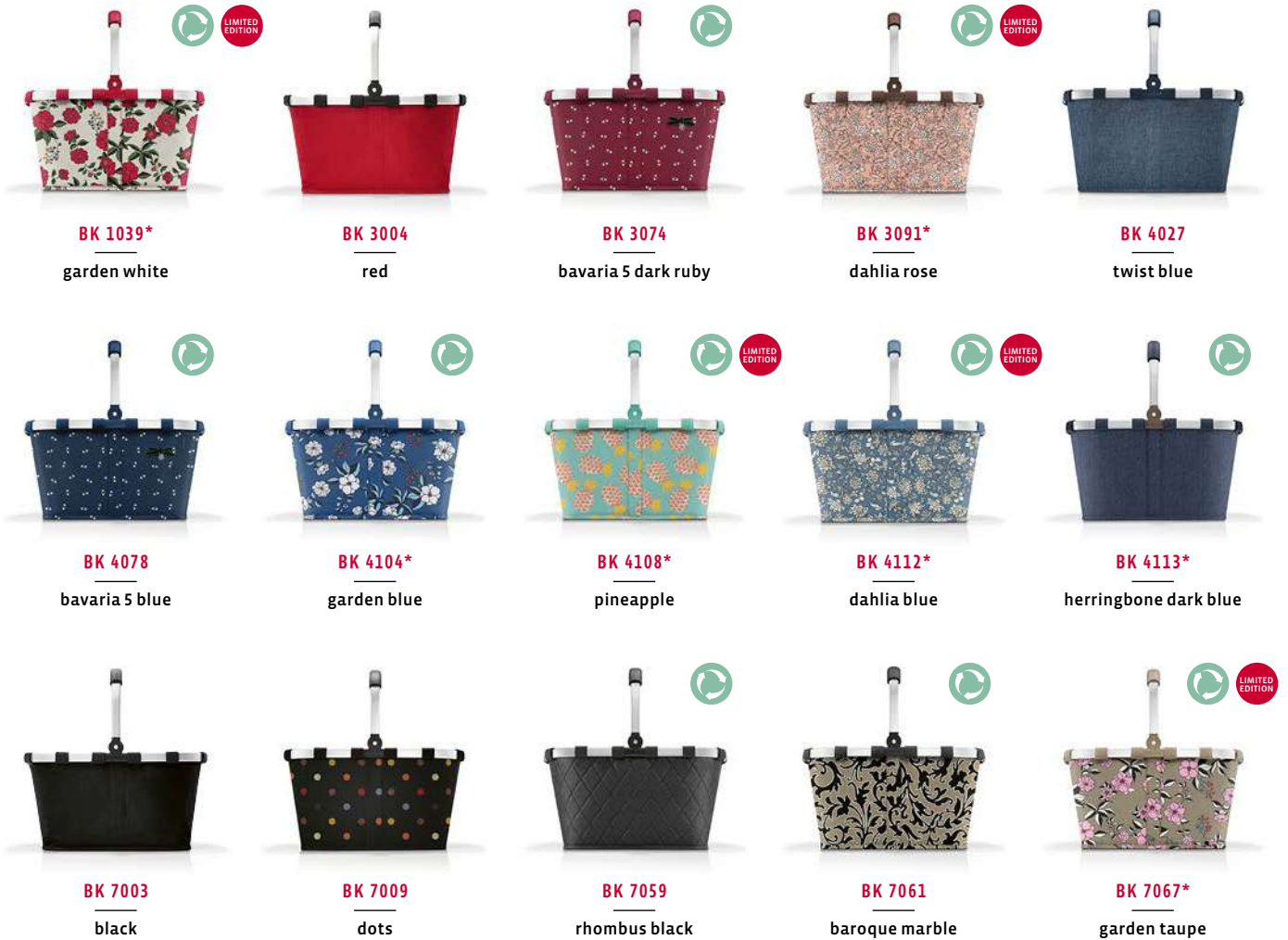

## CARRYBAG® COVER

↳ 48,5 x 6,5 x 28,5 cm

VE/UNIT 8/24



# CARRYBAG® FRAME

**BEST  
SELLER**

reisenthel  
**ORIGINAL**



└ 48 x 29 x 28 cm  
□ 22 l

VE/UNIT 4/12

Design Award 2004  
**DESIGN PLUS**

□ Focus Know-how  
Silber 2005



DESIGNPREIS  
ZUR  
NACHHALTIGKEIT

• **Das Original – heiß begehrt, weltbekannt und schon heute ein Klassiker!**

- frame: stabiler, farbig veredelter Aluminiumrahmen
- Weich ummantelter Griff zum Umklappen
- 1 Innentasche mit Reißverschluss
- Fester Boden mit Standfüßen
- bavaria 6: mit kreativem Print, Stickereien und Verzierungen
- Optionales Zubehör: carrybag cover
- Belastbar bis 20 kg
- Material: hochwertiges Polyestergewebe, wasserabweisend
- Recyceltes Obermaterial: 100 % hochwertiges recyceltes Polyestergewebe (twist Material 50 %), wasserabweisend

• **The original: highly coveted, internationally known and already a classic today!**

- frame: sturdy, colour-refined aluminium frame
- Collapsible soft rubber handle
- 1 zip pocket inside
- Rigid bottom with base feet
- bavaria 6: with creative print, embroidery and decorations
- Optional accessory: carrybag cover
- Loadable up to 20 kg
- Material: premium-quality polyester, water-repellent
- Recycled outer material: 100 % premium-quality recycled polyester (twist material 50 %), water-repellent

• **L'original : un modèle plébiscité et mondialement connu. Déjà un classique !**

- frame : cadre en aluminium stable et raffinement coloré
- Poignée rabattable avec revêtement souple
- 1 poche intérieure zippée
- Fond rigide avec pieds
- bavaria 6 : avec un motif créatif, des broderies et des ornements
- Accessoire en option : carrybag cover
- Résistant jusqu'à 20 kg
- Matière : polyester de haute qualité, déperlant
- Matière principale recyclée : 100 % polyester recyclée de haute qualité (twist matière 50 %), déperlant

# CARRYBAG® FRAME



**BK 1036**  
frame twist sky rose



**BK 3076**  
frame mixed dots red



**BK 3089\***  
frame daisy red



**BK 4073**  
frame signature navy



**BK 4083**  
frame bavaria 6



**BK 4105\***  
frame daisy blue



**BK 4111**  
frame rhombus midnight gold



**BK 4114\***  
frame sumatra



**BK 5047\***  
frame rhombus olive



**BK 6043**  
frame twist coffee



**BK 6046**  
frame rhombus ginger



**BK 7040**  
frame black/black



**BK 7041**  
frame gold/black



**BK 7052**  
frame twist silver



**BK 7054**  
frame signature black



**BK 7062**  
frame rhombus light grey



**BK 7063**  
frame paisley black



**BK 7065\***  
frame op-art



**BK 7068\***  
frame rainbow/black



**BK 7069\***  
frame bronze/black



**BK 7070\***  
frame platinum/black

↳ 48 x 29 x 28 cm  
□ 22 l

VE/UNIT 2/12

# CARRYBAG® XS



↳ 33,5 x 21 x 19,5 cm  
 □ 5 l

VE/UNIT 6/12

• **Das Original in XS – heiß begehrt, weltbekannt und schon heute ein Klassiker!**

- Stabiler Aluminiumrahmen
- Weich ummantelter Griff zum Umklappen
- 1 Innentasche mit Reißverschluss
- Fester Boden mit Standfüßen
- Belastbar bis 8 kg
- Material: hochwertiges Polyester-gewebe, wasserabweisend
- Recyceltes Obermaterial: 100 % hochwertiges recyceltes Polyestergewebe, wasserabweisend

• **The original XS: highly coveted, internationally known and already a classic today!**

- Sturdy aluminium frame
- Collapsible soft rubber handle
- 1 zip pocket inside
- Rigid bottom with base feet
- Loadable up to 8 kg
- Material: premium-quality polyester, water-repellent
- Recycled outer material: 100 % premium-quality recycled polyester, water-repellent

• **L'original XS : un modèle plébiscité et mondialement connu. Déjà un classique !**

- Cadre stable en aluminium
- Poignée rabattable avec revêtement souple
- 1 poche intérieure zippée
- Fond rigide avec pieds
- Résistant jusqu'à 8 kg
- Matière : polyester de haute qualité, déperlant
- Matière principale recyclée : 100 % polyester recyclée de haute qualité, déperlant



**BN 1036\***

frame twist sky rose



**BN 3075**

mixed dots red



**BN 4059**

dark blue



**BN 6043\***

frame twist coffee



**BN 7003**

black



**BN 7009**

dots

# LOOPSHOPPER M



↳ 40 x 26 x 20 cm  
□ 12 l

VE/UNIT 4/12

• **Eleganz beim Einkaufen, viele Funktionen inklusive!**

- Komfortabel gepolsterte Tragegriffe aus stabilem Aluminium
- 1 Innentasche mit Reißverschluss
- 2 Stecktaschen außen
- Fester Boden mit Standfüßen
- Herausnehmbare Innentasche (38 x 23 x 8 cm) mit 3 Fächern
- Recyceltes Obermaterial: 100 % hochwertiges recyceltes Polyestergewebe (twist Material 50 %), wasserabweisend

• **Elegant shopping bag with lots of extra functions included**

- Comfortable padded carrying handles made of strong aluminium
- 1 zip pocket inside
- 2 outside storage pockets
- Rigid bottom with base feet
- Removable interior bag (38 x 23 x 8 cm) with three compartments
- Recycled outer material: 100 % premium-quality recycled polyester (twist material 50 %), water-repellent

• **Faites votre shopping avec classe grâce à ses nombreuses caractéristiques !**

- Poignées en aluminium robuste rembourrées pour un confort maximal
- 1 poche intérieure zippée
- 2 poches extérieures
- Fond rigide avec pieds
- Sac intérieur retirable (38 x 23 x 8 cm) avec 3 compartiments
- Matière principale recyclée : 100 % polyester recyclée de haute qualité (twist matière 50 %), déperlant



OS 1036\*

frame twist sky rose



OS 4113\*

herringbone dark blue



OS 7052\*

frame twist silver

# LOOPSHOPPER L



└ 46 x 34,5 x 25 cm

□ 25 l

VE/UNIT 4/12

• **Eleganz beim Einkaufen, viele Funktionen inklusive**

- Komfortabel gepolsterte Tragegriffe aus stabilem Aluminium
- frame: stabiler, farbig veredelter Aluminiumrahmen
- Über der Schulter und in der Hand zu tragen
- 1 Innentasche mit Reißverschluss
- 2 Stecktaschen außen
- Fester Boden mit Standfüßen
- rhombus black: modernes 3-D-Steppdesign
- Recyceltes Obermaterial: 100 % hochwertiges recyceltes Polyestergewebe (twist Material 50 %), wasserabweisend

• **Elegant shopping with lots of extra functions included**

- Comfortable padded carrying handles made of strong aluminium
- frame: sturdy, colour-refined aluminium frame
- Can be carried over the shoulder or by hand
- 1 zip pocket inside
- 2 outside storage pockets
- Rigid bottom with base feet
- rhombus black: modern 3-D quilted design
- Recycled outer material: 100 % premium-quality recycled polyester (twist material 50 %), water-repellent

• **Faites votre shopping avec classe – nombreuses astuces pratiques**

- Poignées en aluminium rigides rembourrées pour un confort maximal
- frame : cadre en aluminium stable et raffinement coloré
- Peut également être porté à l'épaule
- 1 poche intérieure zippée
- 2 poches extérieures
- Fond rigide avec pieds
- rhombus black : motif matelassé moderne en 3D
- Matière principale recyclée : 100 % polyester recyclée de haute qualité (twist matière 50 %), déperlant



## LOOPSHOPPER L



OR 4027

twist blue



OR 4113\*

herringbone dark blue



OR 7059

rhombus black



OR 7061

baroque marble

## LOOPSHOPPER L FRAME



OR 1036

frame twist sky rose



OR 3076

frame mixed dots red



OR 4073

frame signature navy



OR 4111

frame rhombus  
midnight gold



OR 4114\*

frame sumatra



OR 5047\*

frame rhombus olive



OR 6043

frame twist coffee



OR 7040

frame black



OR 7052

frame twist silver



OR 7056

frame dots



OR 7062

frame rhombus light grey



OR 7063

frame paisley black



OR 7065\*

frame op-art

# EASYSHOPPINGBAG

↳ 32,5 x 38 x 51 cm  
(36,5 x 6 x 6 cm)  
□ 30 l

VE/UNIT 6/24



• **Durchdachte Taschenkonstruktion zum Zusammenrollen**

- 2 stabile Einhängestangen für den Einkaufswagen
- Extrahülle zum Verstauen
- Öffnung durch Klettbander verschließbar
- Trageriemen mit Griffpolster
- 1 Reißverschluss-Innentasche
- 2 Einkaufswagen-Chips im innen liegenden Druckknopf-Täschchen inklusive
- Material: hochwertiges Polyester-gewebe, wasserabweisend
- Recyceltes Obermaterial: 100 % hochwertiges recyceltes Polyestergewebe, wasserabweisend

• **Sophisticated collapsible design**

- 2 stable hanging bars for supermarket trolleys
- Extra cover bag for storage
- Opening can be shut with Velcro strips
- Carrying straps with grip handles
- 1 zip pocket inside
- 2 plastic trolley tokens in small inside pocket with press studs included
- Material: premium-quality polyester, water-repellent
- Recycled outer material: 100 % premium-quality recycled polyester, water-repellent

• **Design malin : peut être enroulé dans sa housse**

- 2 barres de suspension robustes pour le chariot de courses
- Housse séparée pour le rangement
- Ouverture refermable par bandes velcros
- Anses avec poignées rembourrées jointes par des bandes velcros
- 1 poche intérieure zippée
- 2 jetons pour chariot de courses compris dans la petite poche intérieure à bouton-pression
- Matière : polyester de haute qualité, déperlant
- Matière principale recyclée : 100 % polyester recyclée de haute qualité, déperlant



**UJ 3004**  
red



**UJ 3075**  
mixed dots red



**UJ 4059**  
dark blue



**UJ 7003**  
black



**UJ 7009**  
dots



**UJ 7054**  
signature black



**UJ 7061**  
baroque marble



**UJ 7064**  
paisley black

# BOTTLEBAG

**BEST  
SELLER**

24 x 28 x 24 cm  
9 x 0,75 l

VE/UNIT 10/40

- **Steckt literweise ein – und macht alle Wege ganz bequem**
- 2 reißfeste Trageriemen mit Klettband-Kopplung
- Bei Bedarf flach zusammenzulegen
- Das Bodenmaß ist auf handelsübliche Fahrradkörbe zugeschnitten
- Material: hochwertiges Polyester-gewebe, wasserabweisend
- Recyceltes Obermaterial: 100 % hochwertiges recyceltes Polyestergewebe (twist Material 50 %), wasserabweisend
- **A bag for every bottle and maximum convenience**
- 2 tear-proof carrying straps joined by Velcro strips
- Folds flat if needed
- Bottom size corresponds to dimensions of standard bicycle baskets
- Material: premium-quality polyester, water-repellent
- Recycled outer material: 100 % premium-quality recycled polyester (twist material 50 %), water-repellent
- **Un compartiment pour chaque bouteille pour faciliter le transport**
- 2 bandoulières renforcées jointes par bandes velcros
- Pliable à plat si besoin
- Les dimensions du fond correspondent à celles d'un panier de vélo classique
- Matière : polyester de haute qualité, déperlant
- Matière principale recyclée : 100 % polyester recyclée de haute qualité (twist matière 50 %), déperlant



**ZJ 3004**  
red



**ZJ 3075**  
mixed dots red



**ZJ 4027**  
twist blue



**ZJ 4073**  
signature navy



**ZJ 4113\***  
herringbone dark blue



**ZJ 7003**  
black



**ZJ 7009**  
dots



**ZJ 7052**  
twist silver



**ZJ 7061**  
baroque marble



**ZJ 7064**  
paisley black

# SHOULDERBAG S



↳ 29 x 28,5 x 7,5 cm  
 □ 4,7 l

VE/UNIT 6/24

• **Unkomplizierte kleine Umhängetasche**

- Breite, einfach zugängliche Reißverschlussöffnung
- Ins Innenfutter integrierte Reißverschluss tasche
- Verstellbarer Schultergurt
- Recyceltes Obermaterial: 100 % hochwertiges recyceltes Polyestergewebe (twist Material 50 %), wasserabweisend

• **Straightforward small shoulder bag**

- Wide and easily accessible zip opening
- Zipped pocket integrated into the inner lining
- Adjustable shoulder strap
- Recycled outer material: 100 % premium-quality recycled polyester (twist material 50 %), water-repellent

• **Un petit sac à bandoulière tout en simplicité**

- Large ouverture zippée facile d'accès
- Poche intérieure zippée intégrée à la doublure
- Bandoulière réglable
- Matière principale recyclée: 100 % polyester recyclée de haute qualité (twist matière 50 %), déperlant



HY 4073

signature navy



HY 7003

black



HY 7009

dots



HY 7052

twist silver



HY 7061

baroque marble

## SHOPPINGBASKET



└ 48 x 28 x 33 cm  
□ 22 l

VE/UNIT 4/12

• **Lässiger Einkaufsbegleiter mit hoher Funktionalität**

- Harmonisch geformte, flexible Bodenschale
- Flach zusammenlegbar
- 1 Innentasche mit Reißverschluss
- 5 Standfüße für 100 % Bodenfreiheit
- Markanter schmaler Kontraststreifen
- Umgenähte Tragehenkel für bequemen, festen Griff
- Recyceltes Obermaterial: 100 % hochwertiges recyceltes Polyestergewebe (twist Material 50 %), wasserabweisend

• **Casual yet highly functional shopping assistance**

- Beautifully shaped, flexible base panel
- Can be folded flat
- 1 zip pocket inside
- 5 base feet keep basket off the ground
- Distinctive, narrow stripe in contrasting colour
- Double-sewn handle for great carrying comfort
- Recycled outer material: 100 % premium-quality recycled polyester (twist material 50 %), water-repellent

• **Décontracté et fonctionnel, idéal pour faire les courses**

- Coque de fond rigide et de forme harmonieuse
- Pliable à plat
- 1 poche intérieure zippée
- 5 pieds au fond : le panier ne touche pas le sol
- Détail raffiné : une fine bande de couleur contrastante borde la coque de fond
- Poignée conçue pour une prise en main ferme et agréable
- Matière principale recyclée : 100 % polyester recyclée de haute qualité (twist matière 50 %), déperlant



BE 4113\*

herringbone dark blue



BE 7003\*

black



BE 7009\*

dots



BE 7052\*

twist silver



BE 7061\*

baroque marble

# SHOPPER M



↳ 51 x 30,5 x 26 cm  
 □ 15 l

VE/UNIT 6/24

• **Einkaufen mit Funktionalität und Stil – ganz ohne Wenn und Aber**

- Öffnung mit Reißverschluss verschließbar
- 1 Innentasche mit Reißverschluss
- Quadratischer Boden für festen Stand
- Material: hochwertiges Polyester-gewebe, wasserabweisend
- Recyceltes Obermaterial: 100 % hochwertiges recyceltes Polyestergewebe (twist Material 50 %), wasserabweisend

• **Shopping with efficiency and style: the practical shopping experience!**

- Opening can be zipped shut
- 1 zip pocket inside
- Square bottom for extra stability
- Material: premium-quality polyester, water-repellent
- Recycled outer material: 100 % premium-quality recycled polyester (twist material 50 %), water-repellent

• **Un sac fonctionnel et pratique, idéal pour le shopping !**

- Ouverture refermable par une fermeture zippée
- 1 poche intérieure zippée
- Fond carré pour une bonne stabilité
- Matière : polyester de haute qualité, déperlant
- Matière principale recyclée : 100 % polyester recyclée de haute qualité (twist matière 50 %), déperlant

# SHOPPER M



ZS 1035  
twist sky rose



ZS 1039\*  
garden white



ZS 3004  
red



ZS 3075  
mixed dots red



ZS 3090\*  
daisy red



ZS 3091\*  
dahlia rose



ZS 4027  
twist blue



ZS 4073  
signature navy



ZS 4104\*  
garden blue



ZS 4106\*  
daisy blue



ZS 4112\*  
dahlia blue



ZS 4113\*  
herringbone dark blue



ZS 4115\*  
sumatra



ZS 6041  
twist coffee



ZS 7003  
black



ZS 7009  
dots



ZS 7052  
twist silver



ZS 7054  
signature black



ZS 7061  
baroque marble



ZS 7064  
paisley black



ZS 7066\*  
op-art



ZS 7067\*  
garden taupe

\*Ausliefertermin entsprechend der Kollektion | Delivery date according to the collection | Date de livraison selon la collection

# SHOPPER e1

**BEST  
SELLER**

L 50 x 26,5 x 16,5 cm (normal)  
 50 x 35 x 16,5 cm (expanded/déplié)  
 □ 12 l (normal)  
 18 l (expanded/déplié)

VE/UNIT 6/24

#### • Platz für den kleinen und den großen Einkauf

- Öffnung mit Reißverschluss verschließbar
- 2 kurze Trageriemen
- Seitlich umlaufender Reißverschluss vergrößert durch Öffnen das Volumen der Tasche
- 1 Innentasche mit Reißverschluss
- Material: hochwertiges Polyester-gewebe, wasserabweisend
- Recyceltes Obermaterial: 100 % hochwertiges recyceltes Polyestergewebe (twist Material 50 %), wasserabweisend

#### • Space for small and big purchases

- Opening can be zipped shut
- 2 short carrying handles
- Lateral zip increases bag volume when opened
- 1 zip pocket inside
- Material: premium-quality polyester, water-repellent
- Recycled outer material: 100 % premium-quality recycled polyester (twist material 50 %), water-repellent

#### • De la place pour les petits et les gros achats

- Ouverture refermable par une fermeture zippée
- 2 anses courtes
- L'ouverture du zip placé sur le pourtour du sac permet d'augmenter son volume
- 1 poche intérieure zippée
- Matière : polyester de haute qualité, déperlant
- Matière principale recyclée : 100 % polyester recyclée de haute qualité (twist matière 50 %), déperlant



# SHOPPER e1



RJ 1035  
twist sky rose



RJ 1039\*  
garden white



RJ 3075  
mixed dots red



RJ 3090\*  
daisy red



RJ 3091\*  
dahlia rose



RJ 4027  
twist blue



RJ 4073  
signature navy



RJ 4104\*  
garden blue



RJ 4106\*  
daisy blue



RJ 4112\*  
dahlia blue



RJ 4113\*  
herringbone dark blue



RJ 4115\*  
sumatra



RJ 6041  
twist coffee



RJ 7003  
black



RJ 7009  
dots



RJ 7052  
twist silver



RJ 7054  
signature black



RJ 7061  
baroque marble



RJ 7064  
paisley black



RJ 7066\*  
op-art



RJ 7067\*  
garden taupe

# SHOPPER XL



└ 68 x 45,5 x 20 cm  
 □ 35 l

VE/UNIT 6/12

• **Der grundsolide Vielzweckbegleiter für Freizeit und Shopping**

- 2 stabile Trageriemen mit Karabinerhaken
- Öffnung mit Reißverschluss über die volle Breite
- 1 Innentasche mit Reißverschluss
- Stecktasche fürs Mobiltelefon
- Material: hochwertiges Polyestergewebe, wasserabweisend
- Recyceltes Obermaterial: 100 % hochwertiges recyceltes Polyestergewebe (twist Material 50 %), wasserabweisend

• **Stable multipurpose companion for leisure and shopping**

- 2 sturdy carrying straps with snap hooks
- Zip all the way across the opening
- 1 zip pocket inside
- Mobile phone pocket
- Material: premium-quality polyester, water-repellent
- Recycled outer material: 100 % premium-quality recycled polyester (twist material 50 %), water-repellent

• **Le sac multi-usages, solide et résistant. Idéal pour vos virées shopping et vos loisirs**

- 2 anses solides avec mousquetons
- Ouverture avec fermeture zippée sur toute la largeur
- 1 poche intérieure zippée
- Poche de rangement pour téléphone portable
- Matière : polyester de haute qualité, déperlant
- Matière principale recyclée : 100 % polyester recyclée de haute qualité (twist matière 50 %), déperlant

## SHOPPER XL



ZU 1035

twist sky rose



ZU 1039\*

garden white



ZU 3075

mixed dots red



ZU 3090\*

daisy red



ZU 3091\*

dahlia rose



ZU 4027

twist blue



ZU 4073

signature navy



ZU 4104\*

garden blue



ZU 4106\*

daisy blue



ZU 4108\*

pineapple



ZU 4112\*

dahlia blue



ZU 4113\*

herringbone dark blue



ZU 4115\*

sumatra



ZU 6041

twist coffee



ZU 7003

black



ZU 7009

dots



ZU 7052

twist silver



ZU 7061

baroque marble



ZU 7064

paisley black



ZU 7066\*

op-art



ZU 7067\*

garden taupe

# CARRYCRUISER®

**BEST  
SELLER**



└ 42 x 47,5 x 32 cm  
□ 40 l

VE/UNIT 1/1



reddot design award  
winner 2007

#FORM  
2007



Deutscher Designer Club



DESIGNPREIS  
2008



product  
design  
award  
2008

• **Das Multitalent, mit dem alle großen Einkäufe richtig in Fahrt kommen**

- Stabiler Aluminiumrahmen
- frame: stabiler, farbig veredelter Aluminiumrahmen
- Herausnehmbares, waschbares Innenfutter mit Zugverschluss
- Herausnehmbare Netz-Innentasche
- Verstellbarer Schultergurt mit Schulterpolster
- 2-fach ausziehbare Teleskopstange
- Große, leicht laufende, kugelgelagerte Räder
- Standfüße aus Kunststoff
- Clip-Halterungen zum Befestigen am Einkaufswagen
- 2 Einkaufswagen-Chips
- rhombus black: modernes 3-D-Steppdesign
- Optionales Zubehör: carrycruiser cover
- Maximale Griffhöhe: 94 cm
- Belastbar bis 20 kg
- Material: hochwertiges Polyestergewebe, wasserabweisend
- Recyceltes Obermaterial: 100 % hochwertiges recyceltes Polyestergewebe (twist Material 50 %), wasserabweisend

• **This one does it all for you on extensive shopping trips**

- Stable aluminium frame
- frame: sturdy, colour-refined aluminium frame
- Removable, washable lining with toggle fastener
- Removable mesh inner pocket
- Adjustable padded shoulder strap
- 2-stage telescopic handle
- Large, smooth-turning wheels with ball bearings
- Plastic base feet
- Fixtures for attaching to supermarket trolleys
- 2 supermarket trolley tokens
- rhombus black: modern 3-D quilted design
- Optional accessory: carrycruiser cover
- Maximum handle height: 94 cm
- Loadable up to 20 kg
- Material: premium-quality polyester, water-repellent
- Recycled outer material: 100 % premium-quality recycled polyester (twist material 50 %), water-repellent

• **Un cabas aux talents multiples pour répondre à tous vos besoins lors des courses**

- Cadre stable en aluminium
- frame : cadre en aluminium stable et raffinement coloré
- Doublure intérieure amovible, lavable, avec cordon de serrage
- Pochette intérieure en filet amovible
- Bandoulière rembourrée et réglable
- Poignée télescopique rétractable en 2 temps
- Grandes roues à roulements à billes silencieuses et très maniables
- 2 pieds en plastique
- Supports à clips pour fixation au chariot de courses
- 2 jetons pour chariot de courses
- rhombus black : motif matelassé moderne en 3D
- Accessoire en option : carrycruiser cover
- Hauteur maximale de la poignée : 94 cm
- Résistant jusqu'à 20 kg
- Matière : polyester de haute qualité, déperlant
- Matière principale recyclée : 100 % polyester recyclée de haute qualité (twist matière 50 %), déperlant

# CARRYCRUISER®



**OE 3004**  
red



**OE 4027**  
twist blue



**OE 4059**  
dark blue



**OE 4113\***  
herringbone dark blue



**OE 7003**  
black



**OE 7009**  
dots



**OE 7059**  
rhombus black



**OE 7061**  
baroque marble

# CARRYCRUISER® FRAME



**OE 1036**  
frame twist sky rose



**OE 3076**  
frame mixed dots red



**OE 4073**  
frame signature navy



**OE 4111**  
frame rhombus midnight gold



**OE 6043**  
frame twist coffee



**OE 7040**  
frame black/black



**OE 7052**  
frame twist silver



**OE 7054**  
frame signature black



**OE 7062**  
frame rhombus light grey



**OE 7063**  
frame paisley black

# CARRYCRUISER® COVER

↳ 42 x 8 x 33,5 cm

VE/UNIT 4/24



**OG 7003**  
black

# CARRYCRUISER® PLUS



└ 42 X 52,5 X 32 cm  
 □ 46 l

VE/UNIT 1/1

## • Der Klassiker mit mehr Platz und mehr Funktionen

- Großes, bei Bedarf ausfaltbares Thermofach vorne mit Innenfutter aus hochwertiger Aluminiumfolie, abwaschbar
- Deckel mit 2-Wege-Reißverschluss und griffigen Logo-Pullern
- Angenehm tragbar mit gepolstertem Schultergurt
- Stabiler Aluminiumrahmen
- frame: stabiler, farbig veredelter Aluminiumrahmen
- Herausnehmbare Netz-Innentasche
- Passt sich Ihrer Größe an – dank 3-fach ausziehbarer Teleskopstange
- Maximale Griffhöhe: 105 cm
- Große, leicht laufende, kugelgelagerte Räder
- Standfüße aus Kunststoff
- Praktische Clip-Halterungen für den Einkaufswagen
- 2 Einkaufswagen-Chips
- Belastbar bis 20 kg
- Recyceltes Obermaterial: 100 % hochwertiges recyceltes Polyestergewebe (twist Material 50 %), wasserabweisend

## • The classic with more space and more features

- Large thermal compartment at the front, which can be folded out if necessary, with an inner lining made of high-quality aluminium foil, washable
- Lid with 2-way zip and easy-to-grip logo pullers
- Comfortable to carry with a padded shoulder strap
- Stable aluminium frame
- frame: sturdy, colour-refined aluminium frame
- Removable inner mesh pocket
- Adapts to your size – thanks to 3-stage telescopic rod
- Maximum handle height: 105 cm
- Large, smooth-turning wheels with ball bearings
- Plastic feet
- Practical clip fixtures for attaching to supermarket trolleys
- 2 shopping supermarket trolley tokens
- Loadable up to 20 kg
- Recycled outer material: 100 % premium-quality recycled polyester (twist material 50 %), water-repellent

## • Le classique pour plus de place et plus de fonctionnalités

- Grand compartiment isotherme N325, qui peut être déplié si nécessaire, avec une doublure intérieure en feuille d'aluminium de haute qualité, lavable
- Couvercle avec fermeture zippée à double sens et des tirettes-logos faciles à saisir
- Agréable à porter avec sa bandoulière rembourrée à l'épaule
- Cadre stable en aluminium
- frame : cadre en aluminium stable et raffinement coloré
- Pochette intérieure en filet amovible
- S'adapte à votre taille grâce à son manche télescopique réglable en 3 temps
- Hauteur maximale de la poignée : 105 cm
- Grandes roues à roulements à billes très maniables
- Pieds en plastique
- Clips de fixation au chariot de courses très pratiques
- 2 jetons pour chariot de courses
- Résistant jusqu'à 20 kg
- Matière principale recyclée : 100 % polyester recyclée de haute qualité (twist matière 50 %), déperlant

## CARRYCRUISER® PLUS



OF 7009

dots

## CARRYCRUISER® PLUS FRAME



OF 4073

frame signature navy



OF 7040

frame black



OF 7052

frame twist silver

# CITYCRUISER RACK

**4X**  
*Click!* —



↳ 47,5 x 105,5 x 39 cm  
⚖️ 25 kg

VE/UNIT 1/1

• **Kombiniere das citycruiser rack mit einem der bags zu dem idealen Einkaufstrolley**

- Mehrfachnutzen durch stabile Bodenplatte
- Mit Reflektoren zur Sicherheit
- Platzsparend zusammenklappbar
- 4-fach höhenverstellbarer Teleskopgriff
- Große, leicht laufende, 2-fach kugelgelagerte Räder, abnehmbar
- Halterung zum Befestigen am Einkaufswagen
- Zusätzliche Halterung zum Einhängen von Einkaufstaschen
- Belastbar bis 25 kg
- Auch für den Transport von Getränkekästen o. Ä. geeignet
- Maximale Griffhöhe: 105,5 cm
- Material: Eisen, Polypropylen, EVA (Räder)

• **Combine the citycruiser rack with one of the citycruiser bags to create the ideal shopping trolley**

- Multiple advantages owing to the stable base plate
- With reflectors for your safety
- Collapsible and space-saving
- 4 x height-adjustable telescopic handle
- Large, smooth-turning twin ball-bearing wheels, detachable
- Fixtures for attaching to supermarket trolley
- Additional holder to hook in shopping bags
- Loading capacity 25 kg
- Suitable for transporting crates of beverages and similar
- Maximum handle height: 105,5 cm
- Material: iron, polypropylene, EVA (wheels)

• **Combinez le citycruiser rack avec l'un des sacs et obtenez le chariot idéal**

- De multiples avantages grâce à une plaque de fond solide
- Équipé de réflecteurs pour plus de sécurité
- Pliable pour un encombrement minimum
- Poignée télescopique à hauteur réglable en quatre temps
- Grandes roues maniables avec double roulement à billes, détachables
- Support pour fixation au chariot de supermarché
- Crochet supplémentaire pour suspendre d'autres sacs de courses
- Résistant jusqu'à 25 kg
- Adapté au transport de caisses à bouteilles entre autres
- Hauteur maximale de la poignée : 105,5 cm
- Matières : fer, polypropylène, EVA (roues)



DE 7003

black



# CITYCRUISER BAG



└ 34 x 60 x 24 cm  
□ 45 l

VE/UNIT 1/6

#### • Durchdacht bis ins letzte Detail

- Das rack ist im Lieferumfang nicht enthalten und muss extra bestellt werden
- Großes, mit Reißverschluss teilbares Hauptfach
- 2 große, separate Öffnungen mit Reißverschluss
- Abnehmbarer Schultergurt
- Seitliche Außentasche sowie Innentasche mit Reißverschluss
- Zusätzliche Front-Stecktasche
- Seitlicher Schirmhalter
- Belastbar bis 20 kg
- Recyceltes Obermaterial: 100 % hochwertiges recyceltes Polyestergewebe (twist Material 50 %), wasserabweisend

#### • Well thought out down to the last detail

- Rack is not included and must be ordered separately
- Large main compartment, detachable using a zip
- 2 large, separate zipped openings
- Detachable shoulder strap
- Lateral outer pocket and zipped inner pocket
- Additional front pocket
- Lateral umbrella holder
- Loading capacity 20 kg
- Recycled outer material: 100 % premium-quality recycled polyester (twist material 50 %), water-repellent

#### • Pensé dans les moindres détails

- Le rack n'est pas inclus dans la livraison et doit être commandé séparément
- Grand compartiment principal séparable à l'aide d'une fermeture zippée
- 2 grandes ouvertures séparées avec fermeture zippée
- Bandoulière amovible
- Poche latérale extérieure et poche intérieure avec fermeture zippée
- Poche de rangement frontale supplémentaire
- Passant pour parapluie
- Résistant jusqu'à 20 kg
- Matière principale recyclée : 100 % polyester recyclée de haute qualité (twist matière 50 %), déperlant



**DF 4027**  
twist blue



**DF 4073**  
signature navy



**DF 4113\***  
herringbone dark blue



**DF 7003**  
black



**DF 7009**  
dots



**DF 7052**  
twist silver

# TROLLEY M

↳ 43 x 53 x 21 cm

☐ 43 l

VE/UNIT 2/2

- **Der geräumige, flexible und praktische Shopping-Trolley**
- Mit zusätzlichem Stauraum durch Hochstellen der Verschlussklappe
- Komfortabler Transport auf 2 sanft laufenden Rollen
- 2-fach höhenverstellbare Aluminium-Teleskopstange, verschwindet hinter einem Reißverschluss
- frame: stabiler, farbig veredelter Aluminiumrahmen
- 1 Reißverschlussfach auf der Rückseite
- Maximale Griffhöhe: 98 cm
- Belastbar bis 15 kg
- Material: hochwertiges Polyestergewebe, wasserabweisend
- Recyceltes Obermaterial: 100 % hochwertiges recyceltes Polyestergewebe, wasserabweisend

- **The spacious, flexible and practical shopping trolley**
- Additional storage space by raising the flap
- Comfortable transport on 2 near-effortless rollers
- 2-stage aluminium telescopic handle tucks away behind a zipper
- frame: sturdy, colour-refined aluminium frame
- 1 zip pocket on the back
- Maximum handle height: 98 cm
- Loadable up to 15 kg
- Material: premium-quality polyester, water-repellent
- Recycled outer material: 100 % premium-quality recycled polyester, water-repellent

- **Le trolley grande capacité, flexible et pratique**
- Espace de rangement supplémentaire en soulevant le rabat
- Transport aisé grâce aux 2 roues facilement manœuvrables
- Poignée télescopique rétractable en deux temps cachée derrière une fermeture zippée
- frame : cadre en aluminium stable et raffinement coloré
- 1 poche zippée au dos
- Hauteur maximale de la poignée : 98 cm
- Résistant jusqu'à 15 kg
- Matière : polyester de haute qualité, déperlant
- Matière principale recyclée : 100 % polyester recyclée de haute qualité, déperlant



**NT 4027**  
twist blue



**NT 4073**  
frame signature navy



**NT 4113\***  
herringbone dark blue



**NT 7003**  
black



**NT 7009**  
dots



**NT 7052**  
twist silver



**NT 7054**  
frame signature black



**NT 7061**  
baroque marble



**NT 7063**  
frame paisley black

# FOLDABLETROLLEY

↳ 29 x 66 x 27 cm  
(32,5 x 25 x 6,5 cm)

☐ 30 l

VE/UNIT 6/12

• **3-fach gefaltet, dann ganz einfach verpackt – ein wahrer Wunderrolley!**

- Hauptfach mit Druckknopf verschließbar
- Kopplung der Zughenkel mit Klett-Handgriff
- Stabiler Kantenschutz an der unteren Rückwand
- Feste, formstabile Bodenplatte
- Belastbar bis 10 kg
- Maximale Griffhöhe: 85 cm
- Material: hochwertiges Polyester-gewebe, wasserabweisend
- Recyceltes Obermaterial: 100 % hochwertiges recyceltes Polyestergewebe, wasserabweisend

• **Foldable 3 ways for easy storage: a true miracle worker!**

- Main compartment closed with press stud
- Pulling handles are joined by Velcro hand grip
- Sturdy edge protection on bottom backboard
- Firm, dimensionally stable base plate
- Loadable up to 10 kg
- Maximum handle height: 85 cm
- Material: premium-quality polyester, water-repellent
- Recycled outer material: 100 % premium-quality recycled polyester, water-repellent

• **Pliable en trois pour un rangement aisé : un super trolley !**

- Compartiment principal à qui se ferme par bouton-pression
- Poignées jointes par bande velcro
- Protection rigide sur le bord inférieur de la paroi arrière
- Plaque de fond solide et indéformable
- Résistant jusqu'à 10 kg
- Hauteur maximale de la poignée : 85 cm
- Matière : polyester de haute qualité, déperlant
- Matière principale recyclée : 100 % polyester recyclée de haute qualité, déperlant



HK 3004  
red



HK 4113\*  
herringbone  
dark blue



HK 7003  
black



HK 7009  
dots



HK 7061  
baroque marble



HK 7064  
paisley black

# SHOPPER-BACKBACK



GERMAN  
DESIGN  
AWARD  
SPECIAL  
2023



↳ 45 x 44 x 17 cm  
□ 16 l

VE/UNIT 2/12

• **Stylischer Stadtrucksack und Tasche in einem – für Arbeit oder Freizeit**

- Entspricht den vorgeschriebenen Maßen für Handgepäck
- Modernes 3-D-Steppdesign
- Geräumige V-Form: Hauptfach mit 2-Wege-Reißverschluss, passend für 15,6"-Laptop
- 1 Reißverschlussfach außen und innen
- Verstellbare, gepolsterte Schultergurte
- 2 zusätzliche Tragehenkel
- Fester Stand durch rechteckigen Boden
- Recyceltes Obermaterial: 100 % hochwertiges recyceltes Polyestergewebe, wasserabweisend

• **Stylish city backpack and bag in one – for work or leisure**

- Matches the prescribed dimensions for hand luggage
- Modern 3-D quilted design
- Spacious V-shape: main compartment with 2-way zip, fits 15.6" laptop
- 1 zipped compartment outside and inside
- Adjustable, padded shoulder straps
- 2 additional carrying handles
- Stable due to rectangular base
- Recycled outer material: 100 % premium-quality recycled polyester, water-repellent

• **Sac à dos urbain et élégant ou sac tout-en-un – pour le travail comme pour les loisirs**

- Conforme aux dimensions prescrites pour les bagages à main
- Motif matelassé moderne en 3-D
- Forme en V pour une grande contenance : compartiment principal avec fermeture zippée à double sens, convient à un ordinateur portable de 15,6"
- 1 compartiment zippé à l'extérieur et à l'intérieur
- Bretelles réglables et rembourrées
- 2 poignées de transport supplémentaires
- Stable grâce à sa base rectangulaire
- Matière principale recyclée : 100 % polyester recyclée de haute qualité, déperlant



**BJ 7059**

rhombus black



**BJ 7060**

rhombus light grey

# CLASSIC SHOPPER M



↳ 40 x 35 x 13 cm  
 □ 8 l

VE/UNIT 4/12

• **Cleverer Shopper mit nützlichen Details für den Alltag und für abends**

- Modernes 3-D-Steppdesign
- Hauptfach mit Zugverschluss
- 1 Reißverschlussfach außen und innen
- 2 Tragehenkel
- Fester Stand durch rechteckigen Boden
- Recyceltes Obermaterial: 100 % hochwertiges recyceltes Polyestergewebe, wasserabweisend

• **Clever bag with useful details for everyday use and evening**

- Modern 3-D quilted design
- Main compartment with drawstring closure
- 1 zipped compartment outside and inside
- 2 carrying straps
- Rectangular base for stability
- Recycled outer material: 100 % premium-quality recycled polyester, water-repellent

• **Un shopper astucieux avec des détails pratiques pour un usage en journée comme en soirée**

- Motif matelassé moderne en 3-D
- Compartiment principal avec cordon de serrage
- 1 compartiment zippé à l'extérieur et à l'intérieur
- 2 poignées de transport
- Stable grâce à sa base rectangulaire
- Matière principale recyclée : 100 % polyester recyclée de haute qualité, déperlant



**DH 4110**

rhombus midnight gold



**DH 5046\***

rhombus olive



**DH 6045**

rhombus ginger



**DH 7059**

rhombus black



**DH 7060**

rhombus light grey

# CLASSIC SHOPPER L



↳ 39 x 28 x 16 cm  
 □ 12 l

VE/UNIT 4/12

- **Stilvolle Schultertasche für jeden Tag mit viel Platz und praktischen Details**
- Modernes 3-D-Steppdesign
- 2 Hauptfächer und mittiges Reißverschlussfach
- Verschlusslasche mit Druckknopf
- Format durch seitliche Druckknöpfe anpassbar
- 1 Reißverschlussfach innen
- 2 Tragehenkel
- Fester Stand durch rechteckigen Boden
- Recyceltes Obermaterial: 100 % hochwertiges recyceltes Polyestergewebe, wasserabweisend

- **Stylish shoulder bag for every day with plenty of space and practical details**
- Modern 3-D quilted design
- 2 main compartments and central zipped compartment
- Closure flap with snap fastener
- Size can be adjusted with snap fastener at the side
- 1 zipped compartment inside
- 2 carrying straps
- Rectangular base for stability
- Recycled outer material: 100 % premium-quality recycled polyester, water-repellent

- **Un sac à bandoulière élégant pour tous les jours, avec beaucoup de place et des détails astucieux**
- Motif matelassé moderne en 3-D
- 2 compartiments principaux et un compartiment central zippé
- Rabat de fermeture avec bouton pression
- La taille peut être ajustée grâce à des boutons pression latéraux
- 1 compartiment zippé à l'intérieur
- 2 poignées de transport
- Stable grâce à sa base rectangulaire
- Matière principale recyclée: 100 % polyester recyclée de haute qualité, déperlant



**DK 4110**

rhombus midnight gold



**DK 5046\***

rhombus olive



**DK 6045**

rhombus ginger



**DK 7059**

rhombus black



**DK 7060**

rhombus light grey

# CLASSIC SHOPPER XL



↳ 62 x 36 x 22 cm  
 □ 26 l

VE/UNIT 4/12

- **Extragroße Tasche für Strand, Shopping und Supermarkt**
- Modernes 3-D-Steppdesign
- Format kann durch Druckknopfflasche angepasst werden: V-Form oder rechteckig
- Großes Hauptfach mit Druckknopfverschluss
- 1 Reißverschlussfach innen
- 2 Tragehenkel und 2 zusätzliche Schultergurte
- Fester Stand durch rechteckigen Boden
- Recyceltes Obermaterial: 100 % hochwertiges recyceltes Polyestergewebe, wasserabweisend

- **Extra-large bag for the beach, shopping and supermarket**
- Modern 3-D quilted design
- Format can be adjusted by snap fastener: V-shaped or rectangular
- Large main compartment with snap fastener
- 1 zipped compartment inside
- 2 carrying handles and 2 additional shoulder straps
- Stable due to rectangular base
- Recycled outer material: 100 % premium-quality recycled polyester, water-repellent

- **Sac extra-large pour la plage, le shopping et le supermarché**
- Motif matelassé moderne en 3-D
- La forme en V ou rectangulaire peut être ajustée avec le rabat à bouton-pression
- Grand compartiment principal avec fermeture à bouton pression
- 1 compartiment zippé à l'intérieur
- 2 poignées de transport et 2 anses supplémentaires
- Stable grâce à sa base rectangulaire
- Matière principale recyclée : 100 % polyester recyclée de haute qualité, déperlant



**DL 4110**

rhombus midnight gold



**DL 5046\***

rhombus olive



**DL 6045**

rhombus ginger



**DL 7059**

rhombus black



**DL 7060**

rhombus light grey







T

H

E



<b>CARRYCRUISER ISO</b>	<b>50</b>
CARRYBAG ISO	51
<b>THERMOCASE</b>	<b>52</b>
COOLERBAG XS	53
<b>COOLERBAG S POCKET</b>	<b>54</b>
COOLERBAG M POCKET	55
<b>COOLERBAG</b>	<b>56</b>
COOLERBAG XL	58
<b>THERMOSHOPPER</b>	<b>59</b>
COOLER-BACKPACK	61

R

M

O

THERMO

# CARRYCRUISER® ISO



└ 42 x 47,5 x 32 cm  
□ 40 l  
✳ insulated

VE/UNIT 1/1



reddot design award  
winner 2007

#FORM  
2007



Deutscher Designer Club



DESIGNPREIS  
2008



product  
design  
award  
2008

## • Der carrycruiser mit Kühlfunktion

- Isolierende Innenfolie und dicht schließender Deckel mit Reißverschluss
- Stabiler Aluminiumrahmen
- frame: stabiler, farbig veredelter Aluminiumrahmen
- 1 Innentasche mit Reißverschluss
- Verstellbarer Schultergurt mit Schulterpolster
- 2-fach ausziehbare Teleskopstange
- Große, leicht laufende, kugelgelagerte Räder
- Standfüße aus Kunststoff
- Clip-Halterungen zum Befestigen am Einkaufswagen
- 2 Einkaufswagen-Chips
- Maximale Griffhöhe: 94 cm
- Belastbar bis 20 kg
- Material: hochwertiges Polyester-gewebe, wasserabweisend
- Recyceltes Obermaterial: 100 % hochwertiges recyceltes Polyestergewebe (twist Material 50 %), wasserabweisend

## • The carrycruiser with cooling function

- Insulating inner lining and tight-fitting lid with zip
- Stable aluminium frame
- frame: sturdy, colour-refined aluminium frame
- 1 zip pocket inside
- Adjustable padded shoulder strap
- 2-stage telescopic handle
- Large, smooth-turning wheels with ball bearings
- Plastic base feet
- Fixtures for attaching to supermarket trolley
- 2 supermarket trolley tokens
- Maximum handle height: 94 cm
- Loadable up to 20 kg
- Material: premium-quality polyester, water-repellent
- Recycled outer material: 100 % premium-quality recycled polyester (twist material 50 %), water-repellent

## • Le carrycruiser avec fonction isotherme

- Film intérieur isotherme et couvercle hermétique avec fermeture éclair
- Cadre stable en aluminium
- frame : cadre en aluminium stable et raffinement coloré
- 1 poche intérieure zippée
- Bretelle de transport rembourrée et ajustable
- Poignée télescopique rétractable en 2 temps
- Grandes roues à roulements à billes, silencieuses et très maniables
- 2 pieds en plastique
- Supports à clips pour fixation au chariot de courses
- 2 jetons pour chariot de courses
- Hauteur maximale de la poignée : 94 cm
- Résistant jusqu'à 20 kg
- Matière : polyester de haute qualité, déperlant
- Matière principale recyclée : 100 % polyester recyclée de haute qualité (twist matière 50 %), déperlant



OJ 3004

red



OJ 7003

black



OJ 7052

frame twist silver

THERMO

# CARRYBAG® ISO



↳ 48 x 29 x 28 cm  
□ 22 l  
✱ insulated

VE/UNIT 4/12

Design Award 2004  
**DESIGN PLUS**

Focus Know-how  
Silber 2005



• **Der carrybag mit Kühlfunktion**

- Isolierende Innenfolie und dicht schließender Deckel mit Reißverschluss
- Stabiler Aluminiumrahmen
- frame: stabiler, farbig veredelter Aluminiumrahmen
- Weich ummantelter Griff zum Umklappen
- 1 Innentasche mit Reißverschluss
- Bei Bedarf flach zusammenzulegen
- Fester Boden mit Standfüßen
- Material: hochwertiges Polyester-gewebe, wasserabweisend
- Belastbar bis 20 kg
- Recyceltes Obermaterial: 100 % hochwertiges recyceltes Polyestergewebe (twist Material 50 %), wasserabweisend

• **The carrybag with cooling function**

- Insulating inner lining and tight-fitting lid with zip
- Sturdy aluminium frame
- frame: sturdy, colour-refined aluminium frame
- Collapsible soft rubber handle
- 1 zip pocket inside
- Rigid bottom with base feet
- Folds flat if needed
- Material: premium-quality polyester, water-repellent
- Loadable up to 20 kg
- Recycled outer material: 100 % premium-quality recycled polyester (twist material 50 %), water-repellent

• **Le carrybag avec fonction isotherme**

- Film intérieur isotherme et couvercle hermétique avec fermeture à glissière
- Cadre stable en aluminium
- frame : cadre en aluminium stable et raffinement coloré
- Poignée rabattable avec revêtement souple
- 1 poche intérieure zippée
- Fond rigide avec pieds
- Pliable à plat si besoin
- Matière : polyester de haute qualité, déperlant
- Résistant jusqu'à 20 kg
- Matière principale recyclée : 100 % polyester recyclée de haute qualité (twist matière 50 %), déperlant



**BT 3004**  
red



**BT 7003**  
black



**BT 7052**  
frame twist silver

THERMO

# THERMOCASE

**BEST  
SELLER**



↳ 20 x 14 x 6,5 cm

□ 1,5 l

✳ insulated

VE/UNIT 4/24

• **Perfekter kleiner Alltags- und Reisebegleiter**

- Isoliertes Etui für alles, was vor Wärme geschützt werden soll
- Thermo-Innenfutter aus hochwertiger Aluminiumfolie
- Dicht schließender Deckel mit Reißverschluss
- Netzfach innen
- 1 Tragegriff
- Material: hochwertiges Polyester-gewebe, wasserabweisend
- Recyceltes Obermaterial: 100 % hochwertiges recyceltes Polyestergewebe (twist Material 50 %), wasserabweisend

• **The perfect little companion for everyday use and travel**

- Insulated case for anything that should be kept cool
- Thermal lining made of high-quality aluminium foil
- Tight-fitting lid with zip
- Inner mesh pocket
- 1 carrying handle
- Material: premium-quality polyester, water-repellent
- Recycled outer material: 100 % premium-quality recycled polyester (twist material 50 %), water-repellent

• **Le petit accessoire parfait au quotidien et en voyage**

- Étui isotherme pour conserver les aliments à l'abri de la chaleur
- Doublure isotherme en feuille d'aluminium haut de gamme
- Abattant hermétique avec fermeture zippée
- Compartiment en filet à l'intérieur
- 1 poignée
- Matière : polyester de haute qualité, déperlant
- Matière principale recyclée : 100 % polyester recyclée de haute qualité (twist matière 50 %), déperlant



OY 3004

red



OY 4027

twist blue



OY 7003

black



OY 7009

dots



OY 7052

twist silver

THERMO

# COOLERBAG XS



↳ 27,5 x 15,5 x 12 cm

□ 4 l

✱ insulated

VE/UNIT 4/24

• **Smart to go: die kleine coolerbag – perfekt für den carrybag XS!**

- Die kleine Version der coolerbag
- Für Mittagessen oder Picknick
- Thermo-Innenfutter aus hochwertiger Aluminiumfolie
- Dicht schließender Deckel mit 2-Wege-Reißverschluss
- 2 Tragehenkel
- Material: hochwertiges Polyester-gewebe, wasserabweisend
- Recyceltes Obermaterial: 100 % hochwertiges recyceltes Polyester-gewebe (twist Material 50 %), wasserabweisend

• **Smart to go: the small coolerbag – perfect for our carrybag XS!**

- The small version of the coolerbag
- For lunches and picnics
- Thermal lining made of high-quality aluminium foil
- Tight-fitting lid with 2-way zip
- 2 carrying straps
- Material: premium-quality polyester, water-repellent
- Recycled outer material: 100 % premium-quality recycled polyester (twist material 50 %), water-repellent

• **Pour emporter son repas partout : le petit coolerbag astucieux – parfait pour le carrybag XS**

- Le modèle réduit du coolerbag
- Pour le déjeuner ou un pique-nique
- Doublure isotherme en feuille d'aluminium haut de gamme
- Abattant hermétique avec fermeture zippée à double sens
- 2 anses
- Matière : polyester de haute qualité, déperlant
- Matière principale recyclée : 100 % polyester recyclée de haute qualité (twist matière 50 %), déperlant



UF 3004

red



UF 4027

twist blue



UF 7003

black



UF 7009

dots



UF 7052

twist silver

THERMO

# COOLERBAG S POCKET



└ 22,5 x 12 x 18,5 cm

□ 2,5 l

✳ insulated

VE/UNIT 4/24

• **Die ideale Tasche für Lunch, Snacks oder ergänzend beim Einkauf**

- Thermo-Innenfutter aus hochwertiger Aluminiumfolie, pflegeleichte Reinigung
- Dicht schließender Deckel mit 2-Wege-Reißverschluss
- Tragegriff auf dem Deckel
- Recyceltes Obermaterial: 100 % hochwertiges recyceltes Polyestergewebe (twist Material 50 %), wasserabweisend

• **The ideal bag for lunch, snacks or shopping**

- Thermal lining made of high-quality aluminium foil, easy-care cleaning
- Tight-fitting lid with 2-way zip
- Handle on the lid
- Recycled outer material: 100 % premium-quality recycled polyester (twist material 50 %), water-repellent

• **Le sac idéal pour le déjeuner, les collations ou pour les courses**

- Doublure isotherme en feuille d'aluminium de haute qualité, nettoyage facile
- Couverture à fermeture hermétique avec fermeture zippée à double sens
- Poignée sur le couvercle
- Matière principale recyclée: 100 % polyester recyclée de haute qualité (twist matière 50 %), déperlant



LIMITED EDITION

LG 2033\*

twist apricot



LG 4005

navy



LG 4027

twist blue



LG 4073

signature navy



LIMITED EDITION

LG 4084\*

twist azure



LIMITED EDITION

LG 4086\*

twist ocean



LIMITED EDITION

LG 4107\*

twist violet



LIMITED EDITION

LG 4108\*

pineapple



LG 4113\*

herringbone dark blue



LG 7003

black



LG 7009

dots



LG 7052

twist silver

# COOLERBAG M POCKET



└ 28 x 12 x 22,5 cm

□ 4,5 l

✳ insulated

VE/UNIT 4/24

• **Die ideale Tasche für Lunch, Snacks oder ergänzend beim Einkauf**

- Thermo-Innenfutter aus hochwertiger Aluminiumfolie, pflegeleichte Reinigung
- Dicht schließender Deckel mit 2-Wege-Reißverschluss
- Tragegriff auf dem Deckel
- Recyceltes Obermaterial: 100 % hochwertiges recyceltes Polyestergewebe (twist Material 50 %), wasserabweisend

• **The ideal bag for lunch, snacks or shopping**

- Thermal lining made of high-quality aluminium foil, easy-care cleaning
- Tight-fitting lid with 2-way zip
- Handle on the lid
- Recycled outer material: 100 % premium-quality recycled polyester (twist material 50 %), water-repellent

• **Le sac idéal pour le déjeuner, les collations ou pour les courses**

- Doublure isotherme en feuille d'aluminium de haute qualité, nettoyage facile
- Couverture à fermeture hermétique avec fermeture zippée à double sens
- Poignée sur le couvercle
- Matière principale recyclée: 100 % polyester recyclée de haute qualité (twist matière 50 %), déperlant



LIMITED EDITION

LF 2033\*

twist apricot



LF 4005

navy



LF 4027

twist blue



LF 4073

signature navy



LIMITED EDITION

LF 4084\*

twist azure



LIMITED EDITION

LF 4086\*

twist ocean



LIMITED EDITION

LF 4107\*

twist violet



LIMITED EDITION

LF 4108\*

pineapple



LF 4113\*

herringbone dark blue



LF 7003

black



LF 7009

dots



LF 7052

twist silver

THERMO

# COOLERBAG

**BEST  
SELLER**



┆ 44,5 x 24,5 x 25 cm

□ 20 l

✳ insulated

VE/UNIT 4/12

• **Füreinander gemacht, die maßgeschneiderte Ergänzung zum carrybag**

- Sehr dicke Isolierung für höhere Kühlleistung
- Dicht schließender Deckel mit 2-Wege-Reißverschluss
- Thermo-Innenfutter aus hochwertiger Aluminiumfolie, pflegeleichte Handhabung
- 2 Tragehenkel
- Stabiler, widerstandsfähiger Boden
- Material: hochwertiges Polyestergewebe, wasserabweisend
- Recyceltes Obermaterial: 100 % hochwertiges recyceltes Polyestergewebe (twist Material 50 %), wasserabweisend

• **Made for each other, the made-to-measure complement to the carrybag**

- Very thick insulation provides excellent cooling performance
- Tight-fitting lid featuring a 2-way zip
- Thermal lining made of high-quality aluminium foil; low maintenance
- 2 carrying handles
- Sturdy, hard-wearing base
- Material: premium-quality polyester, water-repellent
- Recycled outer material: 100 % premium-quality recycled polyester (twist material 50 %), water-repellent

• **Faits l'un pour l'autre : le complément sur mesure du carrybag**

- Isolation très épaisse pour une capacité de refroidissement optimale
- Abattant hermétique avec fermeture zippée à double sens
- Doublure isotherme en feuille d'aluminium haut de gamme facile d'entretien
- 2 anses
- Fond stable et résistant
- Matière : polyester de haute qualité, déperlant
- Matière principale recyclée : 100 % polyester recyclée de haute qualité (twist matière 50 %), déperlant



# COOLERBAG



**UH 1035**  
twist sky rose



**UH 2033\***  
twist apricot



**UH 3004**  
red



**UH 3075**  
mixed dots red



**UH 4027**  
twist blue



**UH 4073**  
signature navy



**UH 4084\***  
twist azure



**UH 4086\***  
twist ocean



**UH 4107\***  
twist violet



**UH 4108\***  
pineapple



**UH 4113\***  
herringbone dark blue



**UH 7003**  
black



**UH 7009**  
dots



**UH 7052**  
twist silver



**UH 7054**  
signature black

THERMO

# COOLERBAG XL

└ 37 x 41 x 26 cm

□ 30 l

✳ insulated

VE/UNIT 1/6

- **Extragroße Thermotasche für Einkauf, Picknick und Strand**
- Passt perfekt in den carrycruiser
- Dicke Isolierung für hohe Kühlleistung
- Dicht schließender Deckel mit 2-Wege-Reißverschluss
- Fester EVA-Deckel kann als Picknicktisch genutzt werden, mit 2 Mulden für Becher oder Tassen
- Thermo-Innenfutter aus hochwertiger Aluminiumfolie, pflegeleichte Reinigung
- 2 Tragehenkel
- 1 Steckfach außen
- Recyceltes Obermaterial: 100 % hochwertiges recyceltes Polyestergerewebe (twist Material 50 %), wasserabweisend

- **Extra-large thermal bag for shopping, picnics and the beach**
- Fits perfectly into the carrycruiser
- Thick insulation for high cooling performance
- Tight-fitting lid with 2-way zip
- Solid EVA lid can be used as a picnic table, with 2 holders for mugs or cups
- Thermal lining made of high-quality aluminium foil, easy-care cleaning
- 2 handle straps
- 1 outside pocket
- Recycled outer material: 100 % premium-quality recycled polyester (twist material 50 %), water-repellent

- **Très grand sac isotherme pour le shopping, les pique-niques et la plage**
- S'intègre parfaitement dans le carrycruiser
- Isolation épaisse pour une performance de réfrigération optimale
- Abattant hermétique avec fermeture zippée à double sens
- Le couvercle rigide (en matière EVA) peut être utilisé comme table de pique-nique, avec 2 compartiments pour gobelets ou tasses
- Doublure isotherme en feuille d'aluminium de haute qualité, nettoyage facile
- 2 anses
- 1 poche extérieure
- Matière principale recyclée: 100 % polyester recyclée de haute qualité (twist matière 50 %), déperlant



LH 4005  
navy



LH 4073  
signature navy



LH 7003  
black



LH 7009  
dots



LH 7052  
twist silver

# THERMOSHOPPER

**BEST  
SELLER**

38 x 35 x 16 cm  
 15 l  
 insulated

VE/UNIT 4/12

**• Idealer Begleiter für den Einkauf oder das Picknick**

- Thermo-Innenfutter aus hochwertiger Aluminiumfolie
- Dicht schließender Deckel mit 2-Wege-Reißverschluss
- 1 Stecktasche außen
- 2 Trageriemen
- Material: hochwertiges Polyester-gewebe, wasserabweisend
- Recyceltes Obermaterial: 100 % hochwertiges recyceltes Polyestergewebe (twist Material 50 %), wasserabweisend

**• The ideal companion for shopping and picnics**

- Thermal lining made of high-quality aluminium foil
- Tight-fitting lid with 2-way zip
- 1 outer pocket
- 2 carrying straps
- Material: premium-quality polyester, water-repellent
- Recycled outer material: 100 % premium-quality recycled polyester (twist material 50 %), water-repellent

**• Le compagnon idéal pour les courses ou le pique-nique**

- Doublure isotherme en feuille d'aluminium haut de gamme
- Abattant hermétique avec fermeture zippée à double sens
- 1 poche de rangement extérieure
- 2 anses
- Matière : polyester de haute qualité, déperlant
- Matière principale recyclée : 100 % polyester recyclée de haute qualité (twist matière 50 %), déperlant





THERMO

# COOLER-BACKPACK



└ 43 x 43 x 14 cm  
□ 18 l

VE/UNIT 4/24

### • Coole Thermo-Tragetasche und lässiger Rucksack in einem

- Großes, geräumiges Innenfach
- Thermo-Innenfutter aus hochwertiger Aluminiumfolie, pflegeleichte Reinigung
- Große Reißverschlussöffnung
- 1 Außenfach mit Reißverschluss
- 2 Trageriemen, auf der Rückseite verstellbar für Rucksackfunktion
- Recyceltes Obermaterial: 100 % hochwertiges recyceltes Polyestergewebe (twist Material 50 %), wasserabweisend

### • Cool thermal tote bag and casual backpack in one

- Large, spacious inner compartment
- Thermal lining made of high-quality aluminium foil, easy-care cleaning
- Large zip opening
- 1 outer compartment with zip
- 2 handles, adjustable on the back for backpack function
- Recycled outer material: 100 % premium-quality recycled polyester (twist material 50 %), water-repellent

### • À la fois sac isotherme stylé et sac à dos décontracté

- Grand compartiment intérieur spacieux
- Doublure isotherme en feuille d'aluminium de haute qualité, nettoyage facile
- Grande ouverture zippée
- 1 compartiment extérieur avec fermeture éclair
- 2 poignées réglables à l'arrière pour la fonction sac à dos
- Matière principale recyclée : 100 % polyester recyclée de haute qualité (twist matière 50 %), déperlant



LJ 4005  
navy



LJ 4027  
twist blue



LJ 4073  
signature navy



LJ 7003  
black



LJ 7009  
dots



LJ 7052  
twist silver





# MINI MAXI

<b>MINI MAXI RUCKSACK</b>	<b>64</b>
MINI MAXI SHOPPER PLUS	65
<b>MINI MAXI SHOPPER</b>	<b>66</b>
MINI MAXI SHOPPER DISPLAY	68
<b>MINI MAXI SHOPPER POCKET</b>	<b>70</b>
MINI MAXI SHOPPER L	71
<b>MINI MAXI TOURINGBAG</b>	<b>72</b>
MINI MAXI PONCHO	73

MINI MAXI

# MINI MAXI RUCKSACK

**BEST  
SELLER**



30 x 45 x 11 cm (16 x 23 x 2 cm)  
14 l

VE/UNIT 4/48

**• Allzeit bereit, um jedes Transportproblem auf die leichte Schulter zu nehmen**

- In eigener Außentasche kompakt zu verpacken
- Hauptfach mit Reißverschluss
- Zusätzlicher Tragehenkel zwischen den Schultergurten
- Material: hochwertiges Polyester-gewebe, wasserabweisend
- Recyceltes Obermaterial: 100 % hochwertiges recyceltes Polyestergewebe, wasserabweisend

**• Always ready to shoulder your load**

- Can be folded up compactly and stowed away in its own outside pocket
- Main compartment can be zipped shut
- Additional carrying handle between the shoulder straps
- Material: high-quality polyester, water-repellent
- Recycled outer material: 100 % premium-quality recycled polyester, water-repellent

**• Toujours prêt à vous épauler !**

- Rangement compact dans sa propre poche extérieure
- Compartiment principal avec fermeture zippée
- Poignée supplémentaire entre les bretelles
- Matière : polyester de haute qualité, déperlant
- Matière principale recyclée : 100 % polyester recyclée de haute qualité, déperlant



AP 4073

signature navy



AP 7003

black



AP 7009

dots



AP 7054

signature black



AP 7061

baroque marble



AP 7064

paisley black



# MINI MAXI SHOPPER PLUS



┌ 42,5 x 60 x 7 cm (6 x 12 x 2 cm)

□ 20 l

🔄 machine wash cold

VE/UNIT 12/120

• **Beliebtes mini maxi Modell mit mehr Funktionen**

- 3 zusätzliche Steckfächer außen
- Winzig klein zusammenzulegen und mit flexiblem Band zu fixieren
- 2 lange Tragehenkel, auch als Schultergurte zu verwenden
- Material: hochwertiges Polyester-gewebe, wasserabweisend
- Recyceltes Obermaterial: 100 % hochwertiges recyceltes Polyestergewebe, wasserabweisend

• **Popular mini maxi model with more functions**

- 3 additional pockets on the outside
- Folds to mini size and is fixed with a flexible band
- 2 long handles also function as shoulder straps
- Material: high-quality polyester, water-repellent
- Recycled outer material: 100 % premium-quality recycled polyester, water-repellent

• **Incontournable modèle mini maxi avec plus de fonctionnalités**

- 3 poches supplémentaires à l'extérieur
- Minuscule une fois plié et bloqué grâce à un élastique
- 2 longues anses, peut également se porter à l'épaule
- Matière : polyester de haute qualité, déperlant
- Matière principale recyclée : 100 % polyester recyclée de haute qualité, déperlant



AV 4073

signature navy



AV 7009

dots



AV 7054

signature black



AV 7061

baroque marble

MINI MAXI

# MINI MAXI SHOPPER



└ 43,5 x 63 x 6 cm (6 x 12 x 2 cm)

☐ 15 l

🔄 machine wash cold

VE/UNIT 12/120

#### • mini maxi shopper in attraktiven Designs

- Winzig klein zusammenzulegen und mit flexiblem Band zu fixieren
- 2 lange Tragehenkel, auch als Schultergurte zu verwenden
- Material: hochwertiges Polyester-gewebe, wasserabweisend
- Recyceltes Obermaterial: 100 % hochwertiges recyceltes Polyestergewebe, wasserabweisend

#### • mini maxi shopper in attractive patterns

- Folds to mini size and is fixed with a flexible band
- 2 long carrying handles which double as shoulder straps
- Material: premium-quality polyester, water-repellent
- Recycled outer material: 100 % premium-quality recycled polyester, water-repellent

#### • mini maxi shopper avec de nouveaux motifs attrayants

- Minuscule une fois plié, maintenu grâce à un élastique
- 2 longues anses pouvant être portées à l'épaule
- Matière : polyester de haute qualité, déperlant
- Matière principale recyclée : 100 % polyester recyclée de haute qualité, déperlant

# MINI MAXI SHOPPER



AT 3004  
red



AT 3074  
bavaria 5 dark ruby



AT 3075  
mixed dots red



AT 4054  
french blue



AT 4059  
dark blue



AT 4073  
signature navy



AT 4078  
bavaria 5 blue



AT 7003  
black



AT 7009  
dots



AT 7054  
signature black



AT 7061  
baroque marble



AT 7064  
paisley black

## HOW TO FOLD FROM *MAXI* TO *MINI*

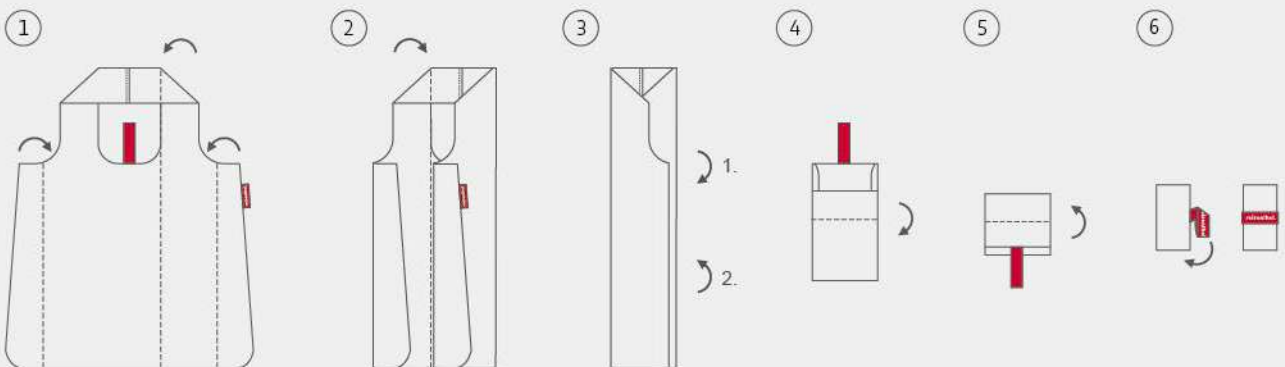

MINI MAXI

# MINI MAXI SHOPPER DISPLAY

**BEST  
SELLER**



L 33,5 x 13 x 20,5 cm

VE/UNIT 48/192



**AT 0002**

mini maxi shopper  
display unicolor  
48 pcs (8 pcs per design)



**AT 0027**

mini maxi shopper  
collection #23 dots  
48 pcs (8 pcs per design)





AT 0035

mini maxi shopper  
collection #31 signature  
48 pcs (3 x 8 pcs per design,  
2 x 12 pcs per design)



AT 0039\*

mini maxi shopper  
collection #35 animal  
48 pcs (3 x 8 pcs per design,  
2 x 12 pcs per design)



AT 0040\*

mini maxi shopper  
collection #36 baroque marble  
48 pcs (3 x 8 pcs per design,  
2 x 12 pcs per design)



AV 0001

mini maxi shopper plus  
collection #1 bicolor  
42 pcs (7 pcs per design)



MINI MAXI

# MINI MAXI SHOPPER POCKET



↳ 45 x 53,5 x 7 cm (5 x 10,5 x 2 cm)  
29,5 x 14 x 41 cm (display)

☐ 15 l

🔄 machine wash cold

VE/UNIT 12/120

VE/UNIT 80/240 (display)

• **Das Original – viel Volumen bei winzigem Packmaß**

- Stets einsatzbereit und umweltfreundlicher als jede Plastiktüte
- In separatem Etui kompakt zu verpacken
- 2 Tragehenkel
- Material: hochwertiges Polyestergewebe, wasserabweisend

• **The original: huge capacity folded into a tiny package**

- Always on hand and better for the environment than any plastic bag
- Can be packed into separate pouch
- 2 carrying handles
- Material: premium-quality polyester, water-repellent

• **L'original : une contenance énorme dans une housse minuscule**

- Toujours à portée de main et plus respectueux de l'environnement qu'un sac en plastique
- À plier de manière compacte dans l'étui séparé
- 2 anses
- Matière : polyester de haute qualité, déperlant



AO 2023

banana cream



AO 2024

autumn glory



AO 3004

red



AO 4054

french blue



AO 4055

damson



AO 5036

spectra green



AO 7003

black



AO 7043

basalt



AO 0058

mini maxi shopper pocket display

MINI MAXI

# MINI MAXI SHOPPER L



↳ 44 x 68 x 9 cm (6,5 x 13 cm)  
39 x 14 x 32 cm (display)

☐ 22 l

🔄 machine wash cold

VE/UNIT 6/72

VE/UNIT 30/120 (display)

• **Auf vielfachen Wunsch wieder mit an Bord: der Immer-dabei-Einkaufsbeutel**

- Mit mehr Volumen, aus Ripstop-Material
- Stets einsatzbereit und umweltfreundlicher als jede Plastiktüte
- In separatem Etui kompakt zu verpacken
- 2 lange Tragehenkel, auch als Schultergurte zu verwenden
- Material: hochwertiges Polyester-gewebe, wasserabweisend

• **Due to great demand, the always-on hand shopping bag is once again available**

- Now in a larger size and made of rip-stop material
- Always ready for use and more environmentally friendly than a plastic bag
- Fits neatly into a separate carrying pouch
- 2 long carrying handles which double as shoulder straps
- Material: premium-quality polyester, water-repellent

• **De retour suite à de nombreuses demandes : le sac de courses à avoir toujours sur soi**

- Plus de volume, en matière ripstop
- Toujours prêt à l'emploi et plus respectueux de l'environnement que les sacs en plastique
- Prend peu de place une fois plié dans la housse séparée
- 2 longues anses, peut également se porter à l'épaule
- Matière : polyester de haute qualité, déperlant



AX 0002

mini maxi shopper L display  
30 pcs (5 pcs per design)



AX 3004

red



AX 4054

french blue



AX 7003

black

MINI MAXI

# MINI MAXI TOURINGBAG



↳ 47,5 x 40 x 20 cm (22 x 16 x 3 cm)  
29,5 x 20 x 41 cm (display)

□ 40 l

VE/UNIT 4/48

#### • Der perfekte Reisebegleiter

- Entspricht den vorgeschriebenen Maßen für Handgepäck
- In der Innentasche kompakt zu verpacken
- 2-Wege-Reißverschluss
- Tragehenkel lassen sich mit gepolsterter Schulterauflage koppeln
- Außentasche mit Reißverschluss vorne
- Trolley-Aufsteckfunktion
- Material: hochwertiges Polyester-gewebe, wasserabweisend

#### • The perfect travel companion

- Matches the prescribed dimensions for hand luggage
- Fits compactly into its inside pocket
- 2-way zip
- Handles can be connected with padded shoulder support
- Front outside pocket with zip
- Sleeve for attaching to a trolley suitcase
- Material: premium-quality polyester, water-repellent

#### • L'accessoire de voyage parfait

- Conforme aux dimensions prescrites pour les bagages à main
- Prend peu de place une fois plié dans la poche intérieure
- Fermeture zippée à double sens
- Un support d'épaule rembourré permet de réunir les anses
- Poche extérieure avec fermeture zippée à l'avant
- Sangle pour le glisser sur une valise à roulettes
- Matière : polyester de haute qualité, déperlant



AD 4059  
dark blue



AD 4073  
signature navy



AD 7003  
black



AD 7009  
dots



AD 7054  
signature black



# MINI MAXI PONCHO

**BEST  
SELLER**



↳ 141 x 93 cm (15 x 21 x 3 cm)  
29,5 x 20 x 41 cm (display)

VE/UNIT 6/24

**• Nimmt kaum Platz in Anspruch und hält leichtem Regen stand**

- In der eigenen Brusttasche auf kleinstes Format zu verpacken
- Unter den Armen jeweils 2 Druckknöpfe
- Weite Kragenöffnung zum leichten An- und Ausziehen
- Einheitsgröße
- Material: hochwertiges Polyester-gewebe, wasserabweisend
- Recyceltes Obermaterial: 100 % hochwertiges recyceltes Polyestergewebe, wasserabweisend

**• Takes up minimal room and withstands light rain**

- Can be folded to minimum size and stowed in its own breast pocket
- 2 press studs under each arm
- Wide collar opening makes it easy to put on and take off
- One size fits all
- Material: premium-quality polyester, water-repellent
- Recycled outer material: 100 % premium-quality recycled polyester, water-repellent

**• Prend peu de place et résiste à une pluie légère**

- Se fait tout petit dans sa propre poche poitrine
- 2 boutons-pression sous chaque bras
- Large ouverture de col pour l'enfiler et l'enlever plus facilement
- Taille unique
- Matière : polyester de haute qualité, déperlant
- Matière principale recyclée : 100 % polyester recyclé de haute qualité, déperlant



**AN 3067**  
paisley ruby



**AN 4059**  
dark blue



**AN 4073**  
signature navy



**AN 7003**  
black



**AN 7009**  
dots



**AN 7054**  
signature black



**AN 7061**  
baroque marble



**AN 7064**  
paisley black





# COSMETIC

<b>CASE 1</b>	<b>76</b>
MULTICASE	77
<b>TRAVELCOSMETIC</b>	<b>78</b>
DUOCASE	79
<b>TOILETBAG</b>	<b>80</b>
TOILETBAG XL	82
<b>WRAPCOSMETIC</b>	<b>84</b>
COSMETICPOUCH M	85

# CASE 1



↳ 24 x 17 cm

VE/UNIT 12/48

• **Universeller Ordnungshelfer für Kosmetik und alle Kleinigkeiten in der Handtasche**

- Reißverschlussöffnung mit extralanger Zughilfe
- Innenfutter
- Material: hochwertiges Polyester-gewebe, wasserabweisend
- Recyceltes Obermaterial: 100 % hochwertiges recyceltes Polyestergewebe, wasserabweisend

• **All-purpose organiser for cosmetics and other small handbag items**

- Zip opening with extra-long pull tab
- Inner lining
- Material: premium-quality polyester, water-repellent
- Recycled outer material: 100 % premium-quality recycled polyester, water-repellent

• **Pochette de rangement universelle pour sac à main destinée aux produits cosmétiques et petits accessoires**

- Fermeture zippée avec tirette extralongue
- Doublure
- Matière : polyester de haute qualité, déperlant
- Matière principale recyclée : 100 % polyester recyclée de haute qualité, déperlant

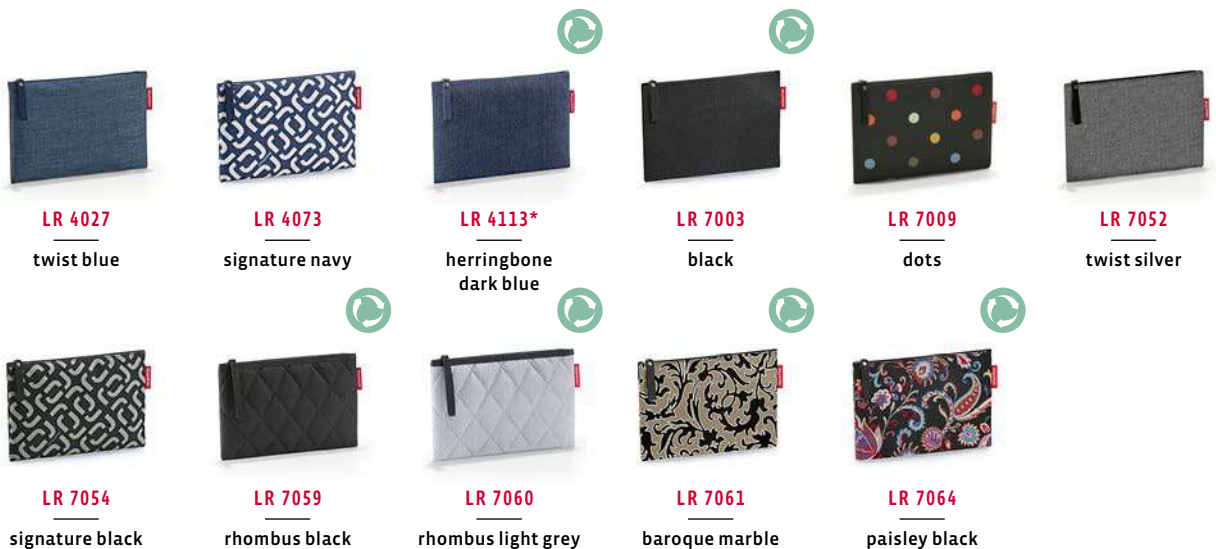

# MULTICASE



↳ 21 x 10 x 7 cm

□ 1,5 l

VE/UNIT 6/36

- **Farbenfroh und vielfach kombinierbar für Schule, Schönheit und Büro**
- Hauptfach mit Reißverschluss
- 1 flaches Reißverschlussfach innen
- 2 Steckfächer innen
- Material: hochwertiges Polyester-gewebe, wasserabweisend
- Recyceltes Obermaterial: 100 % hochwertiges recyceltes Polyestergewebe (twist Material 50 %), wasserabweisend

- **Colourful and infinitely useful for school, office and beauty routines**
- Zipped main compartment
- 1 flat inside pocket with zip
- 2 inside pockets
- Material: premium-quality polyester, water-repellent
- Recycled outer material: 100 % premium-quality recycled polyester (twist material 50 %), water-repellent

- **Colorée et multi-usages : idéale pour les produits cosmétiques et les fournitures scolaires ou de bureau**
- Compartiment principal zippé
- 1 compartiment intérieur plat zippé
- 2 compartiments intérieurs
- Matière : polyester de haute qualité, déperlant
- Matière principale recyclée : 100 % polyester recyclée de haute qualité (twist matière 50 %), déperlant



**WJ 4027**  
twist blue



**WJ 4073**  
signature navy



**WJ 4113\***  
herringbone  
dark blue



**WJ 7003**  
black



**WJ 7009**  
dots



**WJ 7052**  
twist silver



**WJ 7054**  
signature black



**WJ 7061**  
baroque marble

# TRAVELCOSMETIC

**BEST  
SELLER**



└ 26 x 18 x 13,5 cm  
□ 4 l

VE/UNIT 6/24

- **Stabil und komfortabel dank eingearbeiteter Metallbügel**
- 3 Schlaufen an der Innenwand
- 1 Reißverschluss-Innentasche
- Handschlaufe
- Material: hochwertiges Polyester-gewebe, wasserabweisend
- Recyceltes Obermaterial: 100 % hochwertiges recyceltes Polyestergewebe (twist Material 50 %), wasserabweisend

- **Stable and convenient thanks to integrated metal braces**
- 3 loops inside
- 1 zip pocket inside
- Hand strap
- Material: premium-quality polyester, water-repellent
- Recycled outer material: 100 % premium-quality recycled polyester (twist material 50 %), water-repellent

- **Solide et pratique grâce à son armature intégrée en métal**
- 3 élastiques de maintien sur la paroi intérieure
- 1 pochette intérieure zippée
- Dragonne
- Matière : polyester de haute qualité, déperlant
- Matière principale recyclée : 100 % polyester recyclée de haute qualité (twist matière 50 %), déperlant



**WC 1035**  
twist sky rose



**WC 4027**  
twist blue



**WC 4073**  
signature navy



**WC 4104\***  
garden blue



**WC 4110\***  
rhombus midnight gold



**WC 4112\***  
dahlia blue



**WC 4113\***  
herringbone dark blue



**WC 4115\***  
sumatra



**WC 5046\***  
rhombus olive



**WC 7003**  
black



**WC 7009**  
dots



**WC 7052**  
twist silver



**WC 7054**  
signature black



**WC 7059**  
rhombus black



**WC 7061**  
baroque marble



**WC 7064**  
paisley black



**WC 7066\***  
op-art

# DUOCASE



└ 26 x 12,5 x 10 cm  
□ 3 l

VE/UNIT 6/24

• **Alles doppelt im Griff – auf Reisen, in der Schule oder im Büro**

- Geräumiges Etui mit 2 großen Hauptfächern
- Seitlicher Tragegriff
- 1 Reißverschlussfach und 2 Steckfächer innen
- Material: hochwertiges, recyceltes Polyestergewebe, wasserabweisend
- Recyceltes Obermaterial: 100 % hochwertiges recyceltes Polyestergewebe (twist Material 50 %), wasserabweisend

• **Everything under control – when travelling, at school or in the office**

- Spacious case with 2 large main compartments
- Side handle
- 1 zip compartment and 2 open pockets inside
- Material: premium-quality polyester, water-repellent
- Recycled outer material: 100 % premium-quality recycled polyester (twist material 50 %), water-repellent

• **Tout est sous contrôle – en voyage, à l'école ou au bureau**

- Étui spacieux avec 2 grands compartiments principaux
- Poignée latérale
- 1 compartiment zippé et 2 poches ouvertes à l'intérieur
- Matière : polyester de haute qualité, déperlant
- Matière principale recyclée : 100 % polyester recyclée de haute qualité (twist matière 50 %), déperlant



**WA 4073**

signature navy



**WA 7003**

black



**WA 7009**

dots



**WA 7052**

twist silver

COSMETIC

# TOILETBAG

**BEST  
SELLER**



↳ 23 x 20 x 10 cm  
(23 x 55 x 10 cm)

☐ 31

VE/UNIT 6/36

• **Aufklappen und aufhängen – an allen Plätzen zu Hause und auf Reisen!**

- 1 großes Hauptfach aus Netzmaterial mit 4 zusätzlichen Stecktaschen
- 2 Reißverschlussaschen im Deckel
- Haken zum Aufhängen
- Spiegel kann innen mit Klettverschluss angeheftet werden
- Material: hochwertiges Polyester-gewebe, wasserabweisend
- Recyceltes Obermaterial: 100 % hochwertiges recyceltes Polyestergewebe (twist Material 50 %), wasserabweisend

• **Just open and hang it up anywhere: at home or on the road!**

- 1 large main compartment with 4 additional pockets
- 2 zip pockets in the cover
- Suspension hook
- Mirror can be attached to the inside with Velcro
- Material: premium-quality polyester, water-repellent
- Recycled outer material: 100 % premium-quality recycled polyester (twist material 50 %), water-repellent

• **Il suffit de l'ouvrir pour pouvoir l'accrocher, à la maison comme en voyage !**

- 1 compartiment principal en filet avec 4 compartiments additionnels
- 2 poches zippées dans le rabat
- Crochet de suspension
- Le miroir peut être fixé à l'intérieur avec une bande auto-agrippante
- Matière : polyester de haute qualité, déperlant
- Matière principale recyclée : 100 % polyester recyclée de haute qualité (twist matière 50 %), déperlant



# TOILETBAG



**WH 3004**  
red



**WH 4027**  
twist blue



**WH 4073**  
signature navy



**WH 4113\***  
herringbone dark blue



**WH 7003**  
black



**WH 7009**  
dots



**WH 7052**  
twist silver



**WH 7054**  
signature black



**WH 7061**  
baroque marble



**WH 7064**  
paisley black

COSMETIC

# TOILETBAG XL

**BEST  
SELLER**



↳ 28 x 23 x 10 cm  
(28 x 60 x 10 cm)

☐ 4 l

VE/UNIT 6/24

• **Großzügige Kulturtasche für viel Komfort auf langen Reisen**

- 1 geräumiges Hauptfach aus Netzmaterial mit 4 zusätzlichen Stecktaschen
- Zusätzliches Netzfach mit Reißverschluss auf der Front
- 3 Reißverschlussstaschen im Deckel
- Haken zum Aufhängen
- Spiegel kann innen mit Klettverschluss angeheftet werden
- Material: hochwertiges Polyestergewebe, wasserabweisend
- Recyceltes Obermaterial: 100 % hochwertiges recyceltes Polyestergewebe (twist Material 50 %), wasserabweisend

• **Spacious toiletry bag that is extremely convenient on long trips**

- 1 large main compartment with 4 additional pockets
- Additional mesh pocket with zip on the front
- 3 zip pockets on the lid
- Suspension hook
- Mirror can be attached inside with Velcro
- Material: premium-quality polyester, water-repellent
- Recycled outer material: 100 % premium-quality recycled polyester (twist material 50 %), water-repellent

• **Trousse de toilette grand volume pour un confort maximum lors des longs voyages**

- 1 grand compartiment principal en filet et 4 pochettes additionnelles
- Compartiment en filet zippé sur le devant
- 3 poches zippées sous le rabat
- Crochet de suspension
- Possibilité de choisir la position du miroir grâce à une bande auto-agrippante
- Matière : polyester de haute qualité, déperlant
- Matière principale recyclée : 100 % polyester recyclée de haute qualité (twist matière 50 %), déperlant



**WO 3075**  
mixed dots red



**WO 3090\***  
daisy red



**WO 4027**  
twist blue



**WO 4073**  
signature navy



**WO 4104\***  
garden blue



**WO 4113\***  
herringbone dark blue



**WO 4115\***  
sumatra



**WO 6041**  
twist coffee



**WO 7003**  
black



**WO 7009**  
dots



**WO 7052**  
twist silver



**WO 7054**  
signature black



**WO 7061**  
baroque marble



**WO 7064**  
paisley black



**WO 7066\***  
op-art

# WRAPCOSMETIC



↳ 26 x 16 x 10 cm  
(26 x 54 x 10 cm)

☐ 31

VE/UNIT 6/12

**• Moderne Kosmetiktasche zum Aufhängen**

- Zum Aufrollen und Aufhängen, praktisch und platzsparend
- 3 Reißverschlussfächer und 1 Netzfach mit Reißverschluss innen
- 2 Steckfächer
- 2 elastische Schlaufen
- Extrabreiter Spiegel kann innen mit Klettverschluss angeheftet werden
- Formstabil und schützend durch verstärkten Körper
- Recyceltes Obermaterial: 100 % hochwertiges recyceltes Polyestergewebe (twist Material 50 %), wasserabweisend

**• Modern cosmetic bag to hang**

- Can be rolled up and hung up, practical and space-saving
- 3 zip compartments and 1 mesh compartment with zip inside
- 2 open pockets
- 2 elastic loops
- Extra-wide mirror inside can be attached with Velcro
- Dimensionally stable and protective thanks to the reinforced body
- Recycled outer material: 100 % premium-quality recycled polyester (twist material 50 %), water-repellent

**• Trousse de toilette moderne à suspendre**

- S'enroule et s'accroche, pratique et peu encombrante
- 3 compartiments zippés et 1 compartiment intérieur en filet avec zip
- 2 poches ouvertes
- 2 boucles élastiques
- Le miroir extralarge à peut être fixé à l'intérieur avec une bande auto-agrippante
- Stabilité dimensionnelle et protection grâce au corps renforcé
- Matière principale recyclée: 100 % polyester recyclée de haute qualité (twist matière 50 %), déperlant



**WB 4005**  
navy



**WB 4073**  
signature navy



**WB 7003**  
black



**WB 7009**  
dots



**WB 7052**  
twist silver

# COSMETICPOUCH M



↳ 26 x 17 x 9 cm  
□ 3 l

VE/UNIT 4/24

- Kulturbeutel im Unisex-Look, für Hygieneartikel, Kosmetik, Ladekabel und persönliche Dinge
- Modernes 3-D-Steppdesign
- Hauptfach mit großer Reißverschlussöffnung
- 1 Reißverschlussfach und 2 Steckfächer aus Mesh innen
- 1 Tragegriff
- Fester Stand durch rechteckigen Boden
- Recyceltes Obermaterial: 100 % hochwertiges recyceltes Polyestergewebe, wasserabweisend

- Toiletry bag in unisex look, for toiletries, cosmetics, charging cables and personal items
- Modern 3-D quilted design
- Main compartment with large zipped opening
- 1 zipped compartment and 2 mesh pockets inside
- 1 carrying handle
- Stable due to rectangular bottom
- Recycled outer material: 100 % premium-quality recycled polyester, water-repellent

- Trousse de toilette au look unisex, pour les articles de toilette, les cosmétiques, le câble de recharge et les objets personnels
- Motif matelassé moderne en 3D
- Compartiment principal avec grande ouverture zippée
- 1 compartiment zippé et 2 compartiments de rangement en mesh
- 1 poignée de transport
- Stable grâce à sa base rectangulaire
- Matière principale recyclée: 100 % polyester recyclée de haute qualité, déperlant



**BH 7059**

rhombus black



**BH 7060**

rhombus light grey





# Tetra



# Vell



<b>NOTEBOOK BAG</b>	<b>88</b>	<b>ALLROUNDER CROSS</b>	<b>100</b>
NOTEBOOK SLEEVE	89	DAYPACK	102
<b>NETBOOKBAG</b>	<b>90</b>	<b>ALLROUNDER S POCKET</b>	<b>103</b>
WORKBAG	91	ALLROUNDER M	104
<b>SADDLE BAG M</b>	<b>92</b>	<b>ALLROUNDER L</b>	<b>106</b>
ROLLTOP BACKPACK	93	ALLROUNDER L POCKET	108
<b>CLASSIC BACKPACK M</b>	<b>94</b>	<b>ALLROUNDER TROLLEY</b>	<b>109</b>
DUFFELBAG M	95	OVERNIGHTER	110
<b>OVERNIGHTER-BACKPACK M</b>	<b>96</b>	<b>OVERNIGHTER PLUS</b>	<b>111</b>
ALLDAY BACKPACK M	97	ACTIVITYBAG	112
<b>ALLROUNDER R</b>	<b>98</b>	<b>SEATPAD L</b>	<b>113</b>

# NOTEBOOK BAG



↳ 40 x 28,5 x 10 cm  
□ 8,5 l

VE/UNIT 2/12

• **Funktionelle und stylische  
Businessstasche für jeden Tag**

- Modernes 3-D-Steppdesign
- Hauptfach mit 2-Wege-Reißverschluss
- Außen: 1 Reißverschlussfach
- Innen: 1 Reißverschlussfach,  
1 gepolstertes Laptopfach (14")
- Abnehmbarer, verstellbarer  
Schultergurt, 2 Tragegriffe
- Recyceltes Obermaterial:  
100 % hochwertiges recyceltes  
Polyestergewebe, wasserabweisend

• **Functional and stylish  
business bag for everyday use**

- Modern 3-D quilted design
- Main compartment with 2-way zipped  
opening
- Outside: 1 zipped compartment
- Inside: 1 zipped compartment,  
1 padded laptop compartment (14")
- Detachable adjustable shoulder strap,  
2 carrying handles
- Recycled outer material:  
100 % premium-quality recycled  
polyester, water-repellent

• **Sacoch fonctionnelle et  
élégante pour un usage quotidien**

- Motif matelassé moderne en 3-D
- Compartiment principal avec  
fermeture zippée à double sens
- Extérieur: 1 compartiment zippée
- Intérieur: 1 compartiment zippée,  
1 compartiment rembourré pour  
ordinateur portable (14")
- Bandoulière détachable et réglable,  
2 poignées de transport
- Matière principale recyclée:  
100 % polyester recyclée de haute  
qualité, déperlant



**NB 7059\***

rhombus black



**NB 7060\***

rhombus light grey



## NOTEBOOK SLEEVE



↳ 35 x 26 x 2 cm  
□ 4 l

VE/UNIT 4/24

• **Kompakte und stylische Schutzhülle für Laptops**

- Modernes 3-D-Steppdesign
- Gepolstertes Hauptfach mit 2-Wege-Reißverschluss für Laptops (13,5")
- Seitliche Schlaufen zum Anbringen eines Schultergurts (Gurt nicht enthalten!)
- Innen: 2 Steckfächer
- Recyceltes Obermaterial: 100 % hochwertiges recyceltes Polyestergewebe, wasserabweisend

• **Compact and stylish protective sleeve for laptops**

- Modern 3-D quilted design
- Padded main compartment with 2-way zipped opening for laptops (13.5")
- Side loops for attaching a shoulder strap (strap not included!)
- Inside: 2 pockets
- Recycled outer material: 100 % premium-quality recycled polyester, water-repellent

• **Étui de protection compacte et élégante pour les ordinateurs portables**

- Motif matelassé moderne en 3-D
- Compartiment principal rembourré avec fermeture zippée à double sens pour ordinateur portable (13,5")
- Boucles latérales permettant d'attacher une bandoulière (bandoulière non incluse !)
- Intérieur : 2 poches de rangement
- Matière principale recyclée : 100 % polyester recyclée de haute qualité, déperlant



NA 7059\*

rhombus black



NA 7060\*

rhombus light grey

# NETBOOKBAG



↳ 40 x 28,5 x 3,5 cm  
□ 5 l

VE/UNIT 4/12

• **Praktische und stilvolle Tasche für Notebooks mit max. 15,6" Diagonale**

- Gepolstertes Hauptfach mit großer Reißverschlussöffnung
- 2 Steckfächer und 1 Reißverschlussfach außen
- 2 Tragevarianten durch Tragehenkel und abnehmbaren, verstellbaren Schultergurt
- Tragehenkel lassen sich in den Außenfächern verstauen
- Passt perfekt in den allrounder M
- Material: hochwertiges Polyester-gewebe, wasserabweisend

• **Practical and stylish bag for notebooks with a diagonal length of max. 15.6"**

- Padded main compartment with large zip opening
- 2 pockets and 1 zip pocket on the outside
- 2 carrying options with carrying handles and an adjustable removable shoulder strap
- Carrying handles can be stored in outer compartments
- Fits perfectly in the allrounder M
- Material: premium-quality polyester, water-repellent

• **Sac pratique et élégant pour le transport d'ordinateurs portables ayant une diagonale de max. 15,6 pouces**

- Compartiment principal rembourré à grande fermeture zippée
- 2 compartiments et 1 compartiment à fermeture zippée à l'extérieur
- 2 façons de le porter grâce à ses poignées de transport et sa bandoulière réglable et amovible
- Les poignées de transport peuvent se ranger dans les compartiments extérieurs
- Se range parfaitement dans le allrounder M
- Matière : polyester de haute qualité, déperlant



**MA 4059**  
dark blue



**MA 7003**  
black



**MA 7052**  
twist silver

# WORKBAG



↳ 42,5 x 33 x 12 cm  
□ 13 l

VE/UNIT 4/12

• **Bestens organisiert: stylische Tasche für Business und Reisen**

- Frontfach mit Organizer, bestehend aus einem Reißverschlussfach, Steckfächern für Karten, Stiftschlaufen und gepolstertem Steckfach für Smartphones
- Rückseitiges Reißverschlussfach
- 3 Hauptfächer, passend für A4-Unterlagen
- Vorderes und hinteres Hauptfach mit Reißverschluss, mittleres Fach mit Magnet verschließbar
- Vorderes Hauptfach mit 2 Steckfächern und Reißverschlussfach mit Schlüsselhaken
- Hinteres Fach gepolstert für Laptop (15") oder Tablet
- Trolley-Aufsteckfunktion
- 2 kurze Tragehenkel und verstellbarer Tragegurt mit gepolsterter Mesh-Schulterauflage
- Recyceltes Obermaterial: 100 % hochwertiges recyceltes Polyestergewebe (twist Material 50 %), wasserabweisend

• **Perfectly organised: a stylish bag for business and travelling**

- Front compartment with an organiser, consisting of a zip compartment, slots for cards, pen loops and 1 padded compartment for smartphones
- Rear zip compartment
- 3 main compartments to fit A4 documents
- Zipped main compartments at the front and rear, middle compartment with a magnetic close
- Front main compartment with 2 pockets and a zipped compartment with key hooks
- Rear compartment padded for a laptop (15") or tablet
- Sleeve for attaching to a trolley suitcase
- 2 short handles and an adjustable carry strap with mesh shoulder pad
- Recycled outer material: 100 % premium-quality recycled polyester (twist material 50 %), water-repellent

• **Parfaitement organisé : un sac élégant aussi bien pour le travail que pour les voyages**

- Compartiment frontal avec organisateur, comprend un compartiment zippé, des emplacements pour cartes, des passants pour stylos et 1 poche rembourrée pour téléphone portable
- Poche zippée à l'arrière
- 3 compartiments principaux adaptés aux dossiers de format A4
- Compartiments avant et arrière à fermeture zippée, et compartiment central à fermeture aimantée
- Compartiment principal avant comprenant 2 poches de rangement et une poche zippée avec un porte-clés
- Compartiment arrière rembourré pour ordinateur portable (15 pouces) ou tablette
- Sangle sur le côté pour le glisser sur une valise à roulette
- 2 poignées et une bandoulière ajustable avec renfort pour l'épaule en mesh rembourré
- Matière principale recyclée : 100 % polyester recyclée de haute qualité (twist matière 50 %), déperlant



US 7003  
black



US 7052  
twist silver

**NEW  
PRODUCT**

TRAVEL

# SADDLE BAG M



↳ 26 x 22,5 x 10 cm  
☐ 3,5 l

VE/UNIT 2/12

• **Stylische Umhängetasche im Satteltaschen-Look**

- Modernes 3-D-Steppdesign
- Hauptfach mit Klappe und hochwertiger Steckschnalle
- Verstellbarer Schultergurt
- Innen: 1 Reißverschlussfach, 1 Steckfach
- Recyceltes Obermaterial: 100 % hochwertiges recyceltes Polyestergerewebe, wasserabweisend

• **Stylish shoulder bag in saddle bag look**

- Modern 3-D quilted design
- Main compartment with flap and high-quality buckle
- Adjustable shoulder strap
- Inside: 1 zipped compartment, 1 slip compartment
- Recycled outer material: 100 % premium-quality recycled polyester, water-repellent

• **Sac à bandoulière tendance dans le style d'une sacoche**

- Motif matelassé moderne en 3-D
- Compartiment principal avec rabat fermé par une boucle enfichable de qualité
- Bandoulière réglable
- Intérieur : 1 compartiment zippée, 1 compartiment de rangement
- Matière principale recyclée : 100 % polyester recyclée de haute qualité, déperlant



EL 4110\*

rhombus midnight gold



EL 7059\*

rhombus black

# ROLLTOP BACKPACK



↳ 43 x 43 x 17 cm (normal)  
43 x 53 x 17 cm (expanded/  
déplié)

□ 22 l

VE/UNIT 2/12

• **Geräumiger Rucksack für Freizeit, Arbeitsweg und City-Trip**

- Entspricht den vorgeschriebenen Maßen für Handgepäck
- Hauptfach mit Reißverschluss und hochwertiger Metallschnalle
- Oberer Teil der Tasche kann umgeklappt werden
- Außen: 2 Steckfächer, 1 Reißverschlussfach
- Innen: 1 gepolstertes Laptopfach (15,6"), 1 Reißverschlussfach
- Rückseite aus Mesh
- Verstellbare, gepolsterte Schultergurte, 1 Tragegriff
- Recyceltes Obermaterial: 100 % hochwertiges recyceltes Polyestergewebe (twist Material 50 %), wasserabweisend

• **Spacious backpack for leisure, commuting and city trips**

- Matches the prescribed dimensions for hand luggage
- Main compartment with zip and high-quality metal buckle
- Upper part of the bag can be folded down
- Outside: 2 slip compartments, 1 zipped compartment
- Inside: 1 padded laptop compartment (15.6"), 1 zipped compartment
- Mesh back
- Adjustable padded shoulder straps, 1 carrying handle
- Recycled outer material: 100 % premium-quality recycled polyester (twist material 50 %), water-repellent

• **Sac à dos spacieux pour les loisirs, le travail et les déplacements en ville**

- Conforme aux dimensions prescrites pour les bagages à main
- Compartiment principal avec fermeture zippée et boucle métallique de haute qualité
- La partie supérieure du sac peut être repliée
- Extérieur : 2 pochettes, 1 compartiment zippée
- Intérieur : 1 compartiment rembourré pour ordinateur portable (15,6"), 1 compartiment zippée
- Dos en mesh
- Sangles d'épaule rembourrées réglables, 1 poignée de transport
- Matière principale recyclée : 100 % polyester recyclée de haute qualité (twist matière 50 %), déperlant



EK 4113\*

herringbone dark blue



EK 6041\*

twist coffee



EK 7003\*

black



EK 7009\*

dots



EK 7052\*

twist silver

# CLASSIC BACKPACK M



└ 28 x 39 x 12 cm  
□ 13 l

VE/UNIT 2/12

• **Durchdachter Rucksack im Unisex-Look für Arbeit, Reisen und Freizeit**

- Entspricht den vorgeschriebenen Maßen für Handgepäck
- Modernes 3-D-Steppdesign
- Geräumiges Hauptfach mit großer 2-Wege-Reißverschluss-Öffnung
- 1 Reißverschlussfach außen
- 1 Steckfach (13"-Laptop) und 1 Reißverschlussfach innen
- Rückseite aus Mesh für hohen Tragekomfort
- 1 Tragegriff
- Verstellbare, gepolsterte Schultergurte
- Fester Stand durch rechteckigen Boden
- Recyceltes Obermaterial: 100 % hochwertiges recyceltes Polyestergewebe, wasserabweisend

• **Sophisticated backpack in unisex look for work, travel and leisure**

- Matches the prescribed dimensions for hand luggage
- Modern 3-D quilted design
- Spacious main compartment with large 2-way zipped opening
- 1 zipped compartment on the outside
- 1 pocket (laptop 13") and 1 zipped pocket inside
- Mesh back for high carrying comfort
- 1 carrying handle
- Adjustable padded shoulder straps
- Rectangular base for stability
- Recycled outer material: 100 % premium-quality recycled polyester, water-repellent

• **Sac à dos sophistiqué au look unisexe pour le travail, les voyages et les loisirs**

- Conforme aux dimensions prescrites pour les bagages à main
- Motif matelassé moderne en 3D
- Large compartiment principal avec grande ouverture zippée à double sens
- 1 compartiment zippé à l'extérieur
- 1 compartiment (ordinateur portable 13 pouce) et 1 poche zippée à l'intérieur
- Dos en mesh pour un confort élevé
- 1 poignée
- Bretelles réglables et rembourrées
- Stable grâce à sa base rectangulaire
- Matière principale recyclée: 100 % polyester recyclée de haute qualité, déperlant



**CJ 4110**

rhombus  
midnight gold



**CJ 5046\***

rhombus olive



**CJ 6045\***

rhombus ginger



**CJ 7059**

rhombus black



**CJ 7060**

rhombus  
light grey

# DUFFELBAG M



↳ 52 x 37 x 21 cm  
 □ 38 l

VE/UNIT 2/12

### • Stylish vielseitiger Begleiter für Wochenend-Trips, Businessreisen und Alltag

- Entspricht den vorgeschriebenen Maßen für Handgepäck
- Modernes 3-D-Steppdesign
- Geräumiges Hauptfach mit großer 2-Wege-Reißverschluss-Öffnung
- 1 großes und 1 kleines Reißverschlussfach außen
- 1 großes Reißverschlussfach und 2 Mesh-Steckfächer innen
- Abnehmbarer, verstellbarer Schultergurt
- Fester Stand durch rechteckigen Boden
- Standfüße aus Kunststoff
- Recyceltes Obermaterial: 100 % hochwertiges recyceltes Polyestergewebe, wasserabweisend

### • Stylish versatile companion for weekend trips, business trips and everyday life

- Matches the prescribed dimensions for hand luggage
- Modern 3-D quilted design
- Spacious main compartment with large 2-way zipped opening
- 1 large and 1 small zipped compartment on the outside
- 1 large zipped compartment and 2 mesh pockets inside
- Detachable, adjustable shoulder strap
- Rectangular base for stability
- Plastic base feet
- Recycled outer material: 100 % premium-quality recycled polyester, water-repellent

### • Un compagnon élégant et polyvalent pour les week-ends prolongés, les voyages d'affaires et la vie quotidienne

- Conforme aux dimensions prescrites pour les bagages à main
- Motif matelassé moderne en 3D
- Compartiment principal spacieux avec grande ouverture zippée à double sens
- 1 grand et 1 petit compartiment zippés à l'extérieur
- Large compartiment zippé et 2 compartiments de rangement en mesh à l'intérieur
- Bandoulière détachable et réglable
- Stable grâce à sa base rectangulaire
- Pieds en plastique
- Matière principale recyclée : 100 % polyester recyclée de haute qualité, déperlant



BG 7059

rhombus black



BG 7060

rhombus light grey

# OVERNIGHTER-BACKPACK M



└ 30 x 41 x 15 cm

□ 13 l

VE/UNIT 2/12

## • Sportlich-extravaganter Rucksack für Alltag und Arbeit

- Entspricht den vorgeschriebenen Maßen für Handgepäck
- Geräumiges Hauptfach mit viel Platz
- Große Öffnung mit 2-Wege-Reißverschluss
- 1 Außenfach mit XXL-Reißverschluss
- 1 Reißverschlussfach innen im Deckel
- 1 gepolstertes Laptopfach (15,6") plus 1 Reißverschlussfach innen
- Rückseite aus Mesh für hohen Tragekomfort
- Verstellbare, gepolsterte Schultergurte
- 1 Tragehenkel
- Recyceltes Obermaterial: 100 % hochwertiges recyceltes Polyestergewebe (twist Material 50 %), wasserabweisend

## • Sporty and sophisticated backpack for everyday life and work

- Matches the prescribed dimensions for hand luggage
- Spacious main compartment with plenty of room
- Large opening with 2-way zip
- 1 outside compartment with XXL zip
- 1 zipped compartment inside the lid
- 1 padded laptop compartment (15.6") plus 1 zipped compartment inside
- Mesh back for high carrying comfort
- Adjustable padded shoulder straps
- 1 carrying handle
- Recycled outer material: 100 % premium-quality recycled polyester (twist material 50 %), water-repellent

## • Sac à dos sportif et extravagant pour la vie quotidienne et le travail

- Conforme aux dimensions prescrites pour les bagages à main
- Compartiment principal de grande contenance
- Grande ouverture avec fermeture zippée à double sens
- 1 compartiment extérieur avec zip XXL
- 1 compartiment zippé à l'intérieur du couvercle
- 1 compartiment rembourré pour ordinateur portable (15,6") et 1 compartiment intérieur zippé
- La face arrière du backpack en mesh pour un confort maximum
- Bretelles réglables et rembourrées
- 1 poignée de transport
- Matière principale recyclée: 100 % polyester recyclée de haute qualité (twist matière 50 %), déperlant



**EG 4027**  
twist blue



**EG 4059**  
dark blue



**EG 4113\***  
herringbone  
dark blue



**EG 7003**  
black



**EG 7052**  
twist silver



# ALLDAY BACKPACK M



30 x 39 x 13 cm

15 l

VE/UNIT 2/12

- **Vielseitiger Tages-Rucksack für Arbeitsweg, Shoppingtour oder City-Trip**
- Entspricht den vorgeschriebenen Maßen für Handgepäck
- Geräumiges Hauptfach mit 2-Wege-Reißverschluss
- 1 großes und 1 kleines Reißverschlussfach außen
- 1 gepolstertes Laptopfach (15,6") und 1 Reißverschlussfach innen
- Verstellbare, gepolsterte Schultergurte
- 2 Tragegriffe
- Recyceltes Obermaterial: 100 % hochwertiges recyceltes Polyestergewebe (twist Material 50 %), wasserabweisend

- **Versatile day backpack for commuting, shopping or city trips**
- Matches the prescribed dimensions for hand luggage
- Spacious main compartment with 2-way zip
- 1 large and 1 small zipped compartment on the outside
- 1 padded laptop compartment (15.6") and 1 zipped compartment inside
- Adjustable padded shoulder straps
- 2 carrying handles
- Recycled outer material: 100 % premium-quality recycled polyester (twist material 50 %), water-repellent

- **Sac à dos polyvalent pour le trajet domicile-travail, le shopping ou les déplacements en ville**
- Conforme aux dimensions prescrites pour les bagages à main
- Compartiment principal spacieux avec fermeture zippée à double sens
- 1 grand et 1 petit compartiment zippé à l'extérieur
- 1 compartiment rembourré pour ordinateur portable (15,6") et 1 compartiment zippé à l'intérieur
- Bretelles réglables et rembourrées
- 2 poignées de transport
- Matière principale recyclée: 100 % polyester recyclée de haute qualité (twist matière 50 %), déperlant



**EJ 1035**  
twist sky rose



**EJ 3075**  
mixed dots red



**EJ 3077**  
twist berry



**EJ 4027**  
twist blue



**EJ 4073**  
signature navy



**EJ 4113\***  
herringbone dark blue



**EJ 6041**  
twist coffee



**EJ 7003**  
black



**EJ 7009**  
dots



**EJ 7052**  
twist silver

# ALLROUNDER R

**BEST  
SELLER**

L 31 x 39 x 17 cm

□ 12 l

VE/UNIT 2/12

• **Rundum mobil! Das durchdachte 2-in-1-Prinzip (handliche Tragetasche und Rucksack in einem) überzeugt auf Reisen wie auch auf dem Weg zur Uni oder ins Büro**

- Entspricht den vorgeschriebenen Maßen für Handgepäck
- Geräumiges Hauptfach (13"-Laptop)
- Große Öffnung mit Reißverschluss und eingearbeitetem Metallbügel
- 3 Steckfächer und 1 Reißverschlussfach innen
- 2 Steckfächer und 1 Reißverschlussfach außen
- Rückseitige Stecklasche zur Befestigung an Reisetrolley-Griffen
- 2 Tragehenkel
- Verstellbare Schultergurte
- Material: hochwertiges Polyester-gewebe, wasserabweisend
- Recyceltes Obermaterial: 100 % hochwertiges recyceltes Polyestergewebe (twist Material 50 %), wasserabweisend

• **All-round mobile! Its smart 2-in-1 principle (convenient handbag and rucksack in one) makes it the perfect bag for all occasions, whether you're on holiday or headed to uni or work**

- Matches the prescribed dimensions for hand luggage
- Spacious main compartment (laptop 13")
- Large opening with zip and integrated metal frame
- 3 pockets and 1 zip pocket on the inside
- 2 pockets and 1 zip pocket on the outside
- Strap on back to attach to the handles of a trolley suitcase
- 2 carrying handles
- Adjustable shoulder straps
- Material: premium-quality polyester, water-repellent
- Recycled outer material: 100 % premium-quality recycled polyester (twist material 50 %), water-repellent

• **La mobilité en tout point ! L'astucieux principe 2 en 1 (sac cabas pratique et sac à dos) séduit en voyage de même que sur le chemin de l'université ou du bureau**

- Conforme aux dimensions prescrites pour les bagages à main
- Compartiment principal spacieux (ordinateur portable 13 pouces)
- Grande ouverture avec fermeture zippée et armature en métal intégrée
- 3 compartiments et 1 compartiment à fermeture zippée à l'intérieur
- 2 compartiments et 1 compartiment à fermeture zippée à l'extérieur
- Langouette au dos pour fixer le sac sur les poignées d'une valise à roulettes
- 2 poignées
- Bandoulière réglable
- Matière : polyester de haute qualité, déperlant
- Matière principale recyclée : 100 % polyester recyclée de haute qualité (twist matière 50 %), déperlant

# ALLROUNDER R



JR 1035

twist sky rose



JR 3075

mixed dots red



LIMITED EDITION

JR 3090\*

daisy red



JR 4027

twist blue



JR 4073

signature navy



JR 4110

rhombus midnight gold



JR 4113\*

herringbone dark blue



JR 5046\*

rhombus olive



JR 6041

twist coffee



JR 7003

black



JR 7009

dots



JR 7052

twist silver



JR 7054

signature black



JR 7061

baroque marble



JR 7064

paisley black



JR 7066\*

op-art

# ALLROUNDER CROSS

**BEST  
SELLER**

└ 22 x 24 x 13 cm  
□ 4 l

VE/UNIT 4/12



• **Angesagte Crossbody Bag für jeden Tag**

- Abnehmbarer, verstellbarer Schultergurt mit Karabinerhaken
- 2 Tragehenkel
- Öffnung mit Reißverschluss und eingearbeitetem Metallbügel
- 2 Reißverschlussfächer außen
- 3 Steckfächer und 1 Reißverschlussfach innen
- Seitenwände und Boden leicht gepolstert
- Material: hochwertiges Polyestergewebe, wasserabweisend
- Recyceltes Obermaterial: 100 % hochwertiges recyceltes Polyestergewebe (twist Material 50 %), wasserabweisend

• **Fashionable crossbody bag for every day**

- Removable adjustable shoulder strap with snap hook
- 2 carrying handles
- Opening with zip and integrated metal frame
- 2 zip pockets on the outside
- 3 pockets and 1 zip pocket on the inside
- Lightly padded side walls and base
- Material: premium-quality polyester, water-repellent
- Recycled outer material: 100 % premium-quality recycled polyester (twist material 50 %), water-repellent

• **Un sac à bandoulière tendance pour tous les jours**

- Bandoulière réglable en longueur et amovible avec mousquetons
- 2 poignées
- Ouverture avec fermeture zippée et armature en métal intégrée
- 2 compartiments zippés extérieurs
- 3 compartiments et 1 compartiment à fermeture zippée à l'intérieur
- Côtés et fond légèrement rembourrés
- Matière : polyester de haute qualité, déperlant
- Matière principale recyclée : 100 % polyester recyclée de haute qualité (twist matière 50 %), déperlant

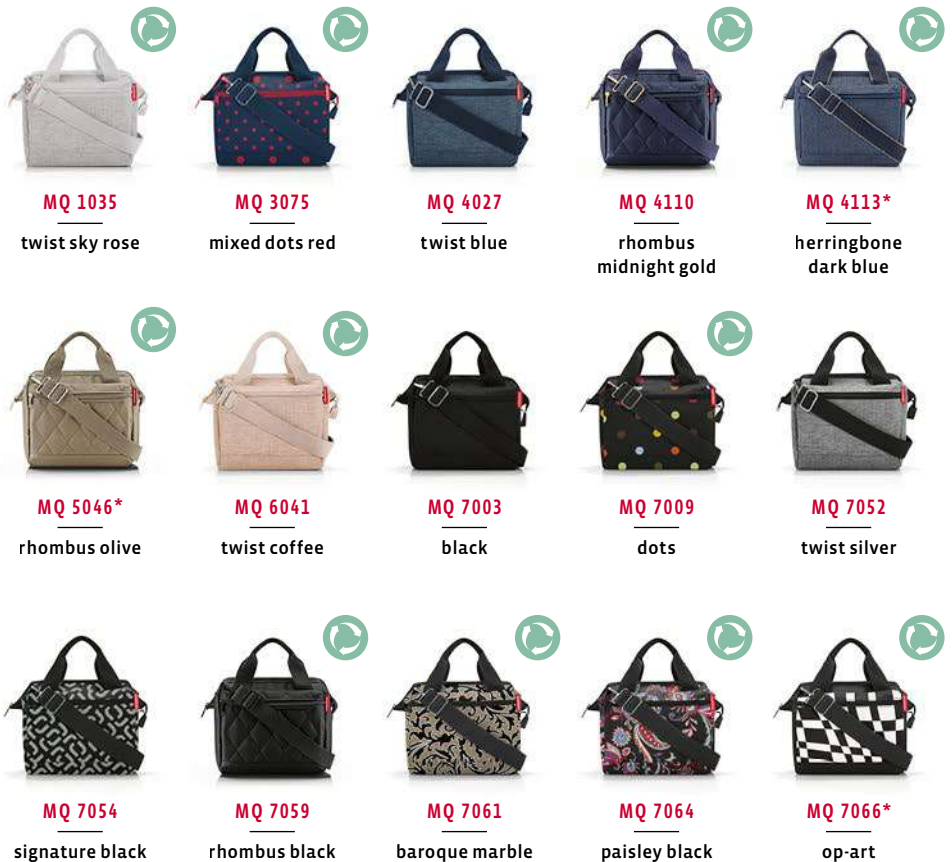



TRAVEL

# DAYPACK



↳ 37 x 43 x 13 cm  
□ 18 l

VE/UNIT 2/12

- **Das durchdachte 2-in-1-Prinzip (handliche Tragetasche und Rucksack in einem) überzeugt auf Reisen wie auch auf dem Weg zur Uni oder ins Büro**
  - Entspricht den vorgeschriebenen Maßen für Handgepäck
  - Geräumiges Hauptfach
  - Gepolsterter Innenteiler für Laptop (17") oder Tablet
  - 1 kleines Reißverschlussfach außen
  - Tragehenkel lassen sich per Klettverschluss koppeln
  - Material: hochwertiges Polyester-gewebe, wasserabweisend
- 
- **Its smart 2-in-1 principle (convenient handbag and rucksack in one) makes it the perfect bag for all occasions, whether you're on holiday or headed to uni or work**
  - Matches the prescribed dimensions for hand luggage
  - Spacious main compartment
  - Padded inner compartment for laptop (17") or tablet
  - 1 small zip pocket on the outside
  - Carrying handles easily attachable with hook-and-loop fastening
  - Material: premium-quality polyester, water-repellent
- 
- **L'astucieux principe 2 en 1 (sac cabas pratique et sac à dos) séduit en voyage, de même que sur le chemin de l'université ou du bureau**
  - Conforme aux dimensions prescrites pour les bagages à main
  - Compartiment principal spacieux
  - Compartiment séparateur rembourré pour ordinateur portable (17 pouces) ou tablette
  - 1 petite poche zippée extérieure
  - 1 bande auto-agrippante permet d'unir les 2 anses
  - Matière : polyester de haute qualité, déperlant



**HH 7052**  
twist silver

# ALLROUNDER S POCKET



└ 39 x 26 x 16,5 cm  
□ 11 l

VE/UNIT 4/12

## • Für Alltag, Reisen und Büro

- Entspricht den vorgeschriebenen Maßen für Handgepäck
- Öffnung mit Reißverschluss und eingearbeiteten Metallbügeln
- Abnehmbarer, verstellbarer Schultergurt mit hochwertigen Karabinerhaken
- 2 Tragehenkel
- 1 Reißverschlussfach außen
- Rückseitige praktische Trolley-Aufsteckfunktion
- 1 Reißverschlussfach und 3 Steckfächer innen
- Hauptfach passend für A4-Unterlagen
- Leicht gepolstert
- Recyceltes Obermaterial: 100 % hochwertiges recyceltes Polyestergerewebe (twist Material 50 %), wasserabweisend

## • For everyday use, travel and the office

- Matches the prescribed dimensions for hand luggage
- Opening with zip and integrated metal brackets
- Removable adjustable shoulder strap with high-quality snap hook
- 2 handles
- 1 outside zip pocket
- Practical trolley suitcase attachment function on the back
- 1 zip compartment and 3 open pockets inside
- Main compartment suitable for A4 documents
- Lightly padded
- Recycled outer material: 100 % premium-quality recycled polyester (twist material 50 %), water-repellent

## • Pour un usage quotidien, les voyages et le bureau

- Conforme aux dimensions prescrites pour les bagages à main
- Ouverture avec fermeture zippée et armature en métal intégrée
- Bandoulière amovible et réglable avec mousqueton de haute qualité
- 2 poignées
- 1 poche extérieure zippée
- Système pratique de fixation à la poignée d'une valise à roulettes
- 1 compartiment zippé et 3 poches ouvertes à l'intérieur
- Compartiment principal adapté aux documents A4
- Légèrement rembourré
- Matière principale recyclée : 100 % polyester recyclée de haute qualité (twist matière 50 %), déperlant



**MO 3075**  
mixed dots red



**MO 4027**  
twist blue



**MO 4073**  
signature navy



**MO 4113\***  
herringbone dark blue



**MO 7003**  
black



**MO 7009**  
dots



**MO 7052**  
twist silver



**MO 7061**  
baroque marble



**MO 7064**  
paisley black

# ALLROUNDER M

**BEST  
SELLER**



↳ 40 x 33,5 x 24 cm  
□ 18 l

VE/UNIT 4/12

• **Das Prinzip der Dokortasche – neu durchdacht fürs Leben unterwegs!**

- Entspricht den vorgeschriebenen Maßen für Handgepäck
- Seitenwände und Boden leicht gepolstert
- Öffnung mit Reißverschluss und eingearbeitetem Metallbügel
- 6 Steckfächer innen zur praktischen Aufbewahrung
- Tragegurt mit komfortabel gepolsterter Schulterauflage
- 2 Tragehenkel mit Griffpolster
- Material: hochwertiges Polyester-gewebe, wasserabweisend
- Recyceltes Obermaterial: 100 % hochwertiges recyceltes Polyestergewebe (twist Material 50 %), wasserabweisend

• **Modelled on the traditional doctor's bag: the contemporary interpretation of mobility!**

- Matches the prescribed dimensions for hand luggage
- Lightly padded sides and bottom
- Opening includes zip fastening and integrated metal bracket
- 6 inside pockets for practical storage
- Carrying strap with comfortably padded shoulder supports
- 2 carrying handles with padded grip
- Material: premium-quality polyester, water-repellent
- Recycled outer material: 100 % premium-quality recycled polyester (twist material 50 %), water-repellent

• **Un modèle inspiré par la traditionnelle sacoche de médecin, conçu pour les déplacements**

- Conforme aux dimensions prescrites pour les bagages à main
- Côtés et fond légèrement rembourrés
- Ouverture avec fermeture zippée et armature en métal intégrée
- 6 compartiments intérieurs pour un rangement pratique
- Bandoulière confortablement rembourrée au niveau de l'épaule
- 2 poignées de transport confortables
- Matière : polyester de haute qualité, déperlant
- Matière principale recyclée : 100 % polyester recyclée de haute qualité (twist matière 50 %), déperlant



# ALLROUNDER M



**MS 1035**  
twist sky rose



**MS 3075**  
mixed dots red



**MS 4027**  
twist blue



**MS 4073**  
signature navy



**MS 4104\***  
garden blue



**MS 4112\***  
dahlia blue



**MS 4113\***  
herringbone dark blue



**MS 4115\***  
sumatra



**MS 6041**  
twist coffee



**MS 7003**  
black



**MS 7009**  
dots



**MS 7052**  
twist silver



**MS 7054**  
signature black



**MS 7061**  
baroque marble



**MS 7064**  
paisley black



**MS 7066\***  
op-art



**MS 4110**  
rhombus midnight gold



**MS 5046\***  
rhombus olive



**MS 7059**  
rhombus black

↳ 40 x 33,5 x 24 cm  
□ 18 l

VE/UNIT 2/12

TRAVEL

# ALLROUNDER L

**BEST  
SELLER**



↳ 48 x 39,5 x 29 cm  
□ 30 l

VE/UNIT 4/12

• **Das Prinzip der Dokortasche – neu durchdacht fürs Leben unterwegs!**

- Seitenwände und Boden leicht gepolstert
- Öffnung mit Reißverschluss und eingearbeitetem Metallbügel
- 6 Steckfächer innen zur praktischen Aufbewahrung
- Tragegurt mit komfortabel gepolsterter Schulterauflage
- 2 Tragehenkel mit Griffpolster
- Material: hochwertiges Polyestergewebe, wasserabweisend
- Recyceltes Obermaterial: 100 % hochwertiges recyceltes Polyestergewebe (twist Material 50 %), wasserabweisend

• **Modelled on the traditional doctor's bag: the contemporary interpretation of mobility!**

- Lightly padded sides and bottom
- Opening includes zip fastening and integrated metal bracket
- 6 inside pockets for practical storage
- Carrying strap with comfortably padded shoulder supports
- 2 carrying handles with padded grip
- Material: premium-quality polyester, water-repellent
- Recycled outer material: 100 % premium-quality recycled polyester (twist material 50 %), water-repellent

• **Un modèle inspiré par la traditionnelle sacoche de médecin, conçu pour les déplacements**

- Côtés et fond légèrement rembourrés
- Ouverture avec fermeture zippée et armature en métal intégrée
- 6 compartiments intérieurs pour un rangement pratique
- Bandoulière confortablement rembourrée au niveau de l'épaule
- 2 poignées de transport confortables
- Matière : polyester de haute qualité, déperlant
- Matière principale recyclée : 100 % polyester recyclée de haute qualité (twist matière 50 %), déperlant

# ALLROUNDER L



**MT 1035**  
twist sky rose



**MT 3075**  
mixed dots red



**MT 3090\***  
daisy red



**MT 4027**  
twist blue



**MT 4073**  
signature navy



**MT 4104\***  
garden blue



**MT 4112\***  
dahlia blue



**MT 4113\***  
herringbone dark blue



**MT 4115\***  
sumatra



**MT 6041**  
twist coffee



**MT 7003**  
black



**MT 7009**  
dots



**MT 7052**  
twist silver



**MT 7054**  
signature black



**MT 7061**  
baroque marble



**MT 7064**  
paisley black



**MT 7066\***  
op-art



**MT 4110**  
rhombus midnight gold



**MT 5046\***  
rhombus olive



**MT 7059**  
rhombus black

↳ 48 x 39,5 x 29 cm  
□ 30 l

VE/UNIT 2/12

# ALLROUNDER L POCKET



└ 48 x 39,5 x 29 cm  
□ 32 l

VE/UNIT 4/12

## • Der Klassiker mit noch mehr Platz!

- 2 große Reißverschlussaschen außen vergrößern den Stauraum
- Prinzip der Dokortasche mit großer Bügelöffnung
- Fester Boden mit 5 Standfüßen für 100 % Bodenfreiheit
- Praktische Trolley-Aufsteckfunktion
- 6 Steckfächer innen
- Tragegurt mit komfortabel gepolsterter Schulterauflage
- 2 Tragehenkel mit Griffpolster
- Material: hochwertiges Polyester-gewebe, wasserabweisend
- Recyceltes Obermaterial: 100 % hochwertiges recyceltes Polyestergewebe (twist Material 50 %), wasserabweisend

## • The classic with even more space!

- More storage space thanks to 2 large zip pockets on the outside
- Doctor's-bag design with a large reinforced opening
- Firm base with 5 base feet pegs to keep bottom off the ground
- Can be conveniently attached to a trolley suitcase
- 6 inner compartments
- Shoulder strap with comfortable padding
- 2 padded carrying handles
- Material: high-quality polyester, water-repellent
- Recycled outer material: 100 % premium-quality recycled polyester (twist material 50 %), water-repellent

## • Un modèle classique offrant encore plus d'espace !

- 2 grands compartiments avec fermeture zippée à l'extérieur pour plus d'espace de rangement
- Conception similaire à celle d'une sacoche de médecin avec une grande ouverture à arceaux
- Fond solide doté de 5 pieds pour une entière liberté au sol
- Système de fixation à la poignée d'une valise à roulettes très pratique
- 6 compartiments intérieurs
- Bandoulière avec renfort d'épaule confortable et rembourré
- 2 poignées de transport avec rembourrage
- Matière : tissu en polyester de haute qualité, déperlant
- Matière principale recyclée : 100 % polyester recyclée de haute qualité (twist matière 50 %), déperlant



**MK 4073**  
signature navy



**MK 7003**  
black



**MK 7009**  
dots



**MK 7052**  
twist silver



# ALLROUNDER TROLLEY



└ 49 x 41 x 30 cm  
 □ 30 l

VE/UNIT 1/2

#### • Der Klassiker zum Rollen

- Große Öffnung mit Reißverschluss und eingearbeitetem Metallbügel
- 6 Steckfächer innen
- 2 Reißverschlusstaschen außen
- Seitenwände leicht gepolstert
- 2 Tragehenkel mit Griffpolster
- 2 leicht laufende Rollen
- 2-fach höhenverstellbare Teleskopstange
- Boden-Protektoren
- Standfüße für 100 % Bodenfreiheit
- Material: hochwertiges Polyester-gewebe, wasserabweisend

#### • The classic on wheels

- Large zip opening and integrated metal frame
- 6 compartments on the inside
- 2 zip pockets on the outside
- Lightly padded side walls
- 2 padded carrying handles
- 2 smooth-turning wheels
- 2-stage telescopic handle
- Base protectors for rougher terrain
- Plastic feet for 100 % ground clearance
- Material: premium-quality polyester, water-repellent

#### • Notre grand classique à roulettes

- Grande ouverture avec fermeture zippée et armature en métal intégrée
- 6 compartiments intérieurs
- 2 compartiments avec fermeture zippée à l'extérieur
- Parois latérales légèrement rembourrées
- 2 poignées de transport rembourrées
- 2 roues ultramaniabiles
- Poignée télescopique réglable en hauteur sur 2 niveaux
- Éléments protecteurs sur le fond pour rouler sur tous les types de terrains
- Pieds pour une entière liberté au sol
- Matière : polyester de haute qualité, déperlant



MP 4059  
dark blue



MP 7003  
black



MP 7009  
dots



MP 7052  
twist silver

# OVERNIGHTER



↳ 60 x 34 x 26 cm  
 ☐ 45 l

VE/UNIT 2/12

• **Travel in Style: die perfekte Reisetasche für Kurztrips und Traumziele**

- Großes Hauptfach mit XXL-Reißverschluss
- 2 Steckfächer vorne
- Innen: 2 Steckfächer und Organizer, bestehend aus 1 Reißverschlussfach und 2 Steckfächern, davon 1 gepolstert für Smartphones
- 2 Tragehenkel mit Klettverschluss und verstellbarer Tragegurt mit gepolsterter Schulterauflage
- Trolley-Aufsteckfunktion
- Standfüße aus Kunststoff
- Material: hochwertiges Polyestergewebe, wasserabweisend

• **Travel in style: the perfect travel bag for short breaks and dream destinations**

- Large main compartment with XXL zip
- 2 pockets at the front
- Inside: 2 pockets plus an organiser consisting of a zip compartment and 2 pockets, 1 of which is padded for a smartphone
- 2 carrying handles with hook-and-loop fastening and an adjustable carry strap with a shoulder pad
- Sleeve for attaching to a trolley suitcase
- Plastic base feet
- Material: premium-quality polyester, water-repellent

• **Un sac de voyage élégant : idéal pour les courtes escapades et destinations de rêve**

- Grand compartiment principal avec fermeture zippée XXL
- 2 poches de rangement extérieures
- Intérieur : 2 compartiments en maille filet, un organisateur avec poche zippée et 2 poches de rangement dont une rembourrée pour y ranger un téléphone portable
- Poignées latérales joignables par bande auto-agrippante et bandoulière ajustable avec support d'épaule rembourré
- Sangle sur le côté pour le glisser sur une valise à roulettes
- Pieds en plastique
- Matière : polyester de haute qualité, déperlant



**BS 4027**  
twist blue



**BS 4113\***  
herringbone dark blue



**BS 7052**  
twist silver

# OVERNIGHTER PLUS



└ 70 x 38 x 29 cm  
□ 50 l

VE/UNIT 2/12

• **Extragroße, clevere Reise-/ Sporttasche**

- Großes Hauptfach mit XXL-Reißverschluss
- Seitliches Schuhfach mit Zugriff von außen
- 3 Reißverschlussfächer außen
- Innen: 2 Steckfächer, 1 Reißverschlussfach
- 2 Tragegriffe mit Klettverschluss und verstellbarer Tragegurte mit gepolsterter Schulterauflage
- Standfüße aus Kunststoff
- Recyceltes Obermaterial: 100 % hochwertiges recyceltes Polyestergewebe (twist Material 50 %), wasserabweisend

• **Extra-large, smart travel/sports bag**

- Large main compartment with XXL zip
- Side shoe compartment with access from the outside
- 3 zipped compartments on the outside
- Inside: 2 pockets, 1 zipped pocket
- 2 carrying handles with Velcro fastening and adjustable shoulder strap with padded shoulder pad
- Plastic base feet
- Recycled outer material: 100 % premium-quality recycled polyester (twist material 50 %), water-repellent

• **Sac de voyage/sport extra-large et intelligent**

- Grand compartiment principal avec fermeture zippée XXL
- Compartiment latéral pour chaussures avec accès par l'extérieur
- 3 compartiments zippés à l'extérieur
- À l'intérieur : 2 poches à glissière, 1 compartiment zippé
- 2 poignées de transport avec fermeture à bande auto-agrippante et bandoulière réglable avec rembourrage pour les épaules
- Pieds en plastique
- Matière principale recyclée : 100 % polyester recyclée de haute qualité (twist matière 50 %), déperlant



**DM 4027**  
twist blue



**DM 4059**  
dark blue



**DM 4113\***  
herringbone dark blue



**DM 7003**  
black



**DM 7052**  
twist silver

# ACTIVITYBAG



↳ 54 x 33 x 30 cm  
 ☐ 35 l

VE/UNIT 4/12

## • Die dynamische Tasche für Sport oder Reisen

- Hauptfach mit 2-Wege-Reißverschluss
- 2 Netzeinsteckfächer innen
- 2 seitliche Reißverschlussfächer, 1 davon mit Schuh-/Wäschebeutel
- 1 Steckfach außen
- 2 Tragehenkel mit Klettverschluss und verstellbarer Tragegurt mit gepolsterter Schulterauflage
- 5 Standfüße am Boden schützen vor Nässe und Schmutz
- Material: hochwertiges Polyester-gewebe, wasserabweisend
- Recyceltes Obermaterial: 100 % hochwertiges recyceltes Polyestergewebe (twist Material 50 %), wasserabweisend

## • A dynamic bag to take to the gym or on trips

- Main compartment with 2-way zip
- 2 inner net pockets
- 2 zip pockets on the outer sides of the bag, 1 of which can be used as a shoe or laundry bag
- 1 outer pocket
- 2 carrying handles with hook-and-loop fastening and an adjustable carry strap with a shoulder pad
- 5 base feet to protect the bag from getting wet or dirty
- Material: premium-quality polyester, water-repellent
- Recycled outer material: 100 % premium-quality recycled polyester (twist material 50 %), water-repellent

## • Sac dynamique pour le sport ou les voyages

- Compartiment principal à fermeture zippée à double sens
- 2 pochettes en filet dans le compartiment principal
- 2 poches latérales à fermeture zippée, dont l'une pour chaussures ou vêtements
- 1 pochette extérieure
- Poignées latérales joignables par bande auto-agrippante et bandoulière ajustable avec support d'épaule rembourré
- 5 pieds pour protéger le sac de l'humidité et des salissures
- Matière : polyester de haute qualité, déperlant
- Matière principale recyclée : 100 % polyester recyclée de haute qualité (twist matière 50 %), déperlant



**MX 4059**  
dark blue



**MX 4113\***  
herringbone dark blue



**MX 7003**  
black



**MX 7052**  
twist silver



**MX 7061**  
baroque marble



# SEATPAD L



↳ 39 x 28 x 0,7 cm

VE/UNIT 30/120

• Für ein trockenes und gegen Kälte isoliertes Plätzchen im Freien

- Geringes Packmaß, da auf ein Viertel zusammenfaltbar
- Material: hochwertiges Polyester-gewebe, wasserabweisend

• Provides a dry, insulated spot outdoors

- Can be folded to a quarter of its size to save space
- Material: premium-quality polyester, water-repellent

• Un coussin qui vous garde au sec et au chaud lors de vos excursions

- Pliable en quatre pour ne pas prendre de place
- Matière : polyester de haute qualité, déperlant



SL 3004

red



SL 4005

navy



SL 7003

black



SL 7043

basalt

# TRAVEL & DISCOVER

**WEIL TRIPS MIT UNSEREN REISETASCHEN  
NOCH MEHR SPASS MACHEN!**

*BECAUSE TRIPS ARE EVEN MORE FUNNY WITH  
OUR TRAVEL BAGS!*

*VOYAGE & DÉCOUVERTE. PARCE QUE LES  
VOYAGES SONT ENCORE PLUS APPRÉCIABLES  
AVEC NOS SACS DE VOYAGE !*



ALLROUNDER M



ALLROUNDER L



ALLROUNDER TROLLEY



ALLROUNDER S POCKET



ALLROUNDER L POCKET



ACTIVITYBAG



DUFFELBAG M



OVERNIGHTER



OVERNIGHTER PLUS

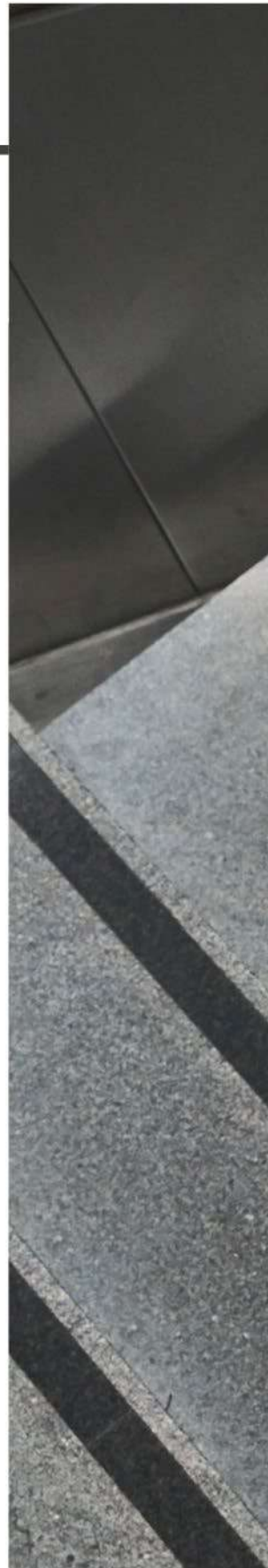



EDITORIAL

SHOPPING

THERMO

MINI MAXI

COSMETIC

**TRAVEL**

UMBRELLA

KIDS

WARDROBE

ABOUT



# WORK &

# FUN



ALLDAY BACKPACK M



CLASSIC BACKPACK M



DAYPACK



SHOPPER-BACKPACK



ROLLTOP BACKPACK



ALLROUNDER R



MINI MAXI RUCKSACK



OVERNIGHTER-BACKPACK M

**RUCKSÄCKE FÜR ALLE!  
PICK YOUR FAVOURITE.**

*BACKPACKS FOR EVERYONE!  
PICK YOUR FAVOURITE.*

**TRAVAIL & LOISIRS.  
DES SACS À DOS POUR TOUS !  
CHOISISSEZ VOTRE PRÉFÉRÉ.**





# BRELLA



reisen<sup>thel</sup>®   
+

<b>UMBRELLA POCKET CLASSIC</b>	<b>121</b>
<b>UMBRELLA POCKET MINI</b>	<b>122</b>
<b>UMBRELLA POCKET DUOMATIC</b>	<b>123</b>



#### UMBRELLA POCKET CLASSIC

Klassisch, stabil und zeitlos! Der praktische, leichtgängige Handöffner ist mit seinem sportlichen Gestell aus Stahl und Fiberglas passend für sie und ihn.

*Classic, stable and timeless! The practical, easy-to-use hand opener with its sporty steel and fiberglass frame is suitable for him and her.*

*Classique, solide et intemporel ! Avec son ouverture manuelle tant facile que pratique et son cadre sportif en acier et fibre de verre, il convient aux femmes comme aux hommes.*



#### UMBRELLA POCKET MINI

mini maxi als Taschenschirm! Extrem leicht und flach. Ausgestattet mit großem Schirmdach und langem Stock ist er ein wahres Kleinraumwunder.

*mini maxi as a pocket umbrella! Extremely light and flat and yet with a large roof and long stick, it's a space-saving miracle.*

*Un parapluie mini maxi au format poche ! Extrêmement léger et plat. Avec sa grande toile et son long mât, c'est un petit génie qui a tout d'un grand.*



#### UMBRELLA POCKET DUOMATIC

Duo-Automatikkomfort der Extra-Klasse mit elegantem Design! Die große Drucktaste sorgt für leichtes, automatisches Öffnen und Schließen. Bequemer geht es nicht.

*Duo-automatic comfort in a class of its own with an elegant design! The large push button ensures comfortable and easy automatic opening and closing.*

*Le confort de l'automatique et l'élégance du design ! Le grand bouton-poussoir garantit une ouverture et une fermeture automatiques d'une seule main. Il n'y a pas plus pratique.*

**reisen**thel<sup>®</sup>  **+**



# UMBRELLA POCKET CLASSIC



99 cm 24 cm 80 km/h

VE/UNIT 2/24

**• Der zeitlose, stylische und kompakte Taschenschirm-Klassiker**

- Leichtgängiger Handöffner mit großem Schirmdach
- Sehr stabil durch robusten Materialmix aus Stahl und Fiberglas
- Sportliches, schwarzes Gestell
- Sturmfest: regelmäßige Tests im Windkanal bis 80 km/h
- Überschlagnssicher: keine Beschädigung durch Umklappen des Schirmdachs
- Sitzt fest in der Hand durch exklusives, ergonomisches Griffdesign und Handschlaufe
- In original Schutzhülle kompakt zu verstauen
- Nach jedem Regeneinsatz aufgespannt trocknen
- Gewicht: 270 g
- Bezugsstoff: 100 % hochwertiges recyceltes Polyestergewebe, schnell-trocknend, wasserabweisend

**• The timeless, stylish and compact pocket umbrella classic**

- Smooth hand opener with large roof
- Very stable thanks to a robust material mix of steel and fiberglass
- Sporty frame in black
- Storm proof: regular tests in the wind tunnel up to 80 km/h
- Flip-over proof: no damage by folding down the roof
- Sits firmly in the hand thanks to the exclusive, ergonomic handle design and wrist strap
- Can be stowed compactly in the original protective cover
- Leave open to dry after use
- Weight: 270 g
- Cover fabric: 100 % premium-quality recycled polyester, quick-drying, water-repellent

**• Le classique du parapluie pliant, intemporel, stylé et compact**

- Ouverture manuelle facile avec une grande couverture
- Très robuste grâce à un matériau solide d'un mélange acier et fibre de verre
- Cadre sportif en noir
- Spécial tempête : tests réguliers en soufflerie jusqu'à 80 km/h
- Résistant au vent : aucun dommage en cas de retournement de la couverture
- Parfaite prise en main grâce à une conception exclusive et ergonomique de la poignée et de la dragonne
- Se range de manière compacte dans la housse d'origine
- Après chaque utilisation sous la pluie, laisser sécher ouvert
- Poids : 270 g
- Matériau textile : 100 % polyester recyclée de haute qualité, séchage rapide, déperlant

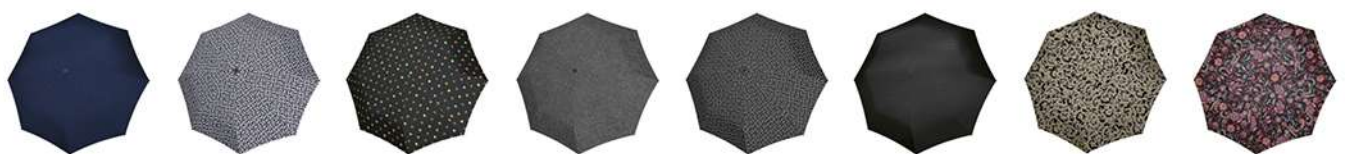

**RS 3075** mixed dots red   
 **RS 4073** signature navy   
 **RS 7009** dots   
 **RS 7052** twist silver   
 **RS 7054** signature black   
 **RS 7058** signature black hot print   
 **RS 7061** baroque marble   
 **RS 7064** paisley black

# UMBRELLA POCKET MINI



97 cm



25 cm



80 km/h

VE/UNIT 2/24

**• Extrem flacher, stabiler und leichter Taschenschirm, mit nur 25 cm ideal für die Tasche**

- Leichtgängiger Handöffner mit großem Schirmdach trotz des kleinen Packmaßes
- Angenehmer Tragekomfort durch langen, silberfarbenen Stock
- Robuste Aluminiumleichtbauweise: Stahlstock, Schiene aus Aluminium
- Sturmfest: regelmäßige Tests im Windkanal bis 80 km/h
- Überschlagnssicher: keine Beschädigung durch Umklappen des Schirmdachs
- Sitzt fest in der Hand durch exklusives Griffdesign und Handschlaufe
- In original Schutzhülle kompakt zu verstauen
- Nach jedem Regeneinsatz aufgespannt trocknen
- Gewicht: 190 g
- Bezugsstoff: 100 % hochwertiges recyceltes Polyestergewebe, schnell-trocknend, wasserabweisend

**• Extremely flat, stable and light pocket umbrella, with only 25 cm perfect for bags**

- Smooth-running hand opener with a large roof despite the small pack size
- Comfortable to carry thanks to the long aluminium-colored stick
- Robust lightweight aluminum construction: steel frame, aluminum rail
- Storm proof: regular tests in the wind tunnel up to 80 km/h
- Flip-over proof: no damage by folding down the roof
- Sits firmly in the hand thanks to the exclusive handle design and wrist strap
- Can be stowed compactly in the original protective cover
- Leave open to dry after use
- Weight: 190 g
- Cover fabric: 100 % premium-quality recycled polyester, quick-drying, water-repellent

**• Parapluie pliant extrêmement plat, robuste et léger, avec seulement 25 cm de diamètre, idéal pour le ranger dans un sac**

- Ouverture manuelle facile avec un grand toit malgré sa petite taille une fois plié
- Confortable à porter grâce au long mât en aluminium
- Armature robuste en aluminium léger: cadre en acier, baleine en aluminium
- Spécial tempête : tests réguliers en soufflerie jusqu'à 80 km/h
- Résistant au vent : aucun dommage en cas de retournement de la couverture
- Parfaite prise en main grâce à une conception exclusive de la poignée et de la dragonne
- Se range de manière compacte dans la housse d'origine
- Après chaque utilisation sous la pluie, laisser sécher ouvert
- Poids : 190 g
- Matériau textile : 100 % polyester recyclé de haute qualité, séchage rapide, déperlant



RT 3075

mixed dots red



RT 4073

signature navy



RT 7009

dots



RT 7052

twist silver



RT 7054

signature black



RT 7058

signature black hot print



RT 7061

baroque marble



RT 7064

paisley black

# UMBRELLA POCKET DUOMATIC



97 cm 28 cm 120 km/h

VE/UNIT 2/24

**• Duomatic-Komfort mit elegantem Design**

- Große Drucktaste für angenehmes, automatisches Öffnen und Schließen mit einer Hand
- Sehr stabil durch robusten Materialmix aus Stahl und Fibreglas
- Sportliches schwarzes Gestell
- Sturmfest: regelmäßige Tests im Windkanal bis 120 km/h
- Überschlagsicher: keine Beschädigung durch Umklappen des Schirmdachs
- Sitzt fest in der Hand durch exklusives, ergonomisches Griffdesign und Handschlaufe
- In original Schutzhülle kompakt zu verstauen
- Nach jedem Regeneinsatz aufgespannt trocknen
- Gewicht: 350 g
- Bezugsstoff: 100 % hochwertiges recyceltes Polyestergewebe, schnell-trocknend, wasserabweisend

**• Duomatic comfort with an elegant design**

- Large push button for convenient, automatic opening and closing with one hand
- Very stable thanks to a robust material mix of steel and fibreglass
- Sporty frame in black
- Storm proof: regular tests in wind tunnel up to 120 km/h
- Flip-over-proof: no damage by folding down the roof
- Sits firmly in the hand thanks to the exclusive, ergonomic handle design and wrist strap
- Can be stowed compactly in the original protective cover
- Leave open to dry after use
- Weight: 350 g
- Cover fabric: 100 % premium-quality recycled polyester, quick-drying, water-repellent

**• Allie confort de l'automatique et l'élégance du design**

- Grand bouton-poussoir pour une ouverture et une fermeture automatique d'une seule main
- Très robuste grâce à un matériau solide d'un mélange acier et fibre de verre
- Cadre sportif en noir
- Spécial tempête : tests réguliers en soufflerie jusqu'à 120 km/h
- Résistant au vent : aucun dommage en cas de retournement de la couverture
- Parfaite prise en main grâce à une conception exclusive et ergonomique de la poignée et de la dragonne
- Se range de manière compacte dans la housse d'origine
- Après chaque utilisation sous la pluie, laisser sécher ouvert
- Poids : 350 g
- Matériau textile : 100 % polyester recyclée de haute qualité, séchage rapide, déperlant



RR 3075 mixed dots red RR 4073 signature navy RR 7009 dots RR 7052 twist silver RR 7054 signature black RR 7058 signature black hot print RR 7061 baroque marble RR 7064 paisley black





<b>CARRYBAG XS KIDS</b>	<b>126</b>
THERMOCASE KIDS	127
<b>MYSAC KIDS</b>	<b>128</b>
BACKPACK KIDS	129
<b>TOILETBAG S KIDS</b>	<b>130</b>
TOILETBAG KIDS	131
<b>ALLROUNDER XS KIDS</b>	<b>132</b>
ALLROUNDER M KIDS	133
<b>TROLLEY XS KIDS</b>	<b>135</b>
BABYCASE	136
<b>BABY ORGANIZER</b>	<b>137</b>

KIDS

# CARRYBAG® XS KIDS

**BEST  
SELLER**



└ 33,5 x 18 x 19,5 cm  
□ 5 l

VE/UNIT 2/12

• **Das Nesthäkchen in der carrybag Familie!**

- Superweicher, klappbarer Tragegriff
- Innentasche mit Reißverschluss
- Reflektierende Elemente für bessere Sichtbarkeit bei Dunkelheit und schlechtem Wetter
- panda/tiger: mit hochwertiger Bestickung
- Belastbar bis 8 kg
- Material: hochwertiges, reißfestes Polyestergewebe, wasserabweisend
- Recyceltes Obermaterial: 100 % hochwertiges recyceltes Polyestergewebe, wasserabweisend

• **The baby of the carrybag family!**

- Ultra-soft folding handle
- Zip interior compartment
- Reflective elements for better visibility in the dark and in bad weather
- panda/tiger: with premium embroidery
- Loadable up to 8 kg
- Material: premium-quality, tear-proof polyester, water-repellent
- Recycled outer material: 100 % premium-quality recycled polyester, water-repellent

• **Le petit dernier de la famille carrybag !**

- Poignée souple rabattable
- Poche intérieure zippée
- Éléments réfléchissants pour une meilleure visibilité dans l'obscurité et par mauvais temps
- panda/tiger : avec une broderie de haute qualité
- Résistant jusqu'à 8 kg
- Matière : polyester de haute qualité, indéchirable et déperlant
- Matière principale recyclée : 100 % polyester recyclée de haute qualité, déperlant



IA 3072

panda dots pink



IA 4077

tiger navy



IA 3064

cats and dogs rose



IA 4062

cats and dogs mint



IA 3066

ABC friends pink



IA 4066

ABC friends blue

# THERMOCASE KIDS

**BEST  
SELLER**



↳ 20 x 14 x 6,5 cm

□ 1,5 l

\* insulated

VE/UNIT 4/24

#### • Ab in die große Pause!

- Das Lunchpaket bleibt lange frisch dank des Thermo-Innenfutters aus Aluminiumfolie
- Kinderleichtes Öffnen und Schließen mit Reißverschluss
- Mit dem Tragegriff hat man die thermocase kids immer fest in der Hand
- 1 Extra-Netzfach innen
- panda/tiger: mit hochwertiger Bestickung
- Material: hochwertiges, reißfestes Polyestergewebe, wasserabweisend
- Recyceltes Obermaterial: 100 % hochwertiges recyceltes Polyestergewebe, wasserabweisend

#### • Time to take a break!

- The thermal lining made of aluminium foil keeps lunch fresh for longer
- A convenient zip for easy opening and closing
- The carrying strap lets you always keep a hand on your thermocase kids
- 1 extra mesh pocket inside
- panda/tiger: with premium embroidery
- Material: premium-quality, tear-proof polyester, water-repellent
- Recycled outer material: 100 % premium-quality recycled polyester, water-repellent

#### • C'est l'heure du goûter !

- La boîte à goûter garde les aliments au frais grâce à la doublure isotherme en feuille d'aluminium
- Ultrafacile à ouvrir et à fermer grâce à sa fermeture zippée
- Poignée pratique pour avoir la sacoche toujours bien en main
- Compartiment en filet à l'intérieur
- panda/tiger : avec une broderie de haute qualité
- Matière : polyester de haute qualité, indéchirable et déperlant
- Matière principale recyclée : 100 % polyester recyclée de haute qualité, déperlant



OY 3072

panda dots pink



OY 4077

tiger navy



OY 3064

cats and dogs rose



OY 4062

cats and dogs mint



OY 3066

ABC friends pink



OY 4066

ABC friends blue

KIDS

# MYSAC KIDS



- └ 30 x 34 cm
- 5 l
- ☑ machine wash cold

VE/UNIT 4/48

• **Der ideale Beutel für Sport und Reisen – sportlich, schick und unschlagbar cool!**

- Geräumiges Hauptfach, mit praktischem Kordelzug verschließbar
- Geht nicht verloren: Namensschild innen
- Material: hochwertiges, reißfestes Polyestergewebe, wasserabweisend

• **The perfect sports and travel bag – sporty elegance and unrivalled coolness!**

- Spacious main compartment, practical drawstring
- You can't lose it: name plate inside
- Material: premium-quality, tear-proof polyester, water-repellent

• **Le sac idéal pour le sport et en voyage – à la fois chic et très cool !**

- Vaste compartiment principal fermant à l'aide d'une cordelette pratique
- Ne risque pas de se perdre grâce au porte-nom à l'intérieur
- Matière : polyester de haute qualité, indéchirable et déperlant



IC 3064

cats and dogs rose



IC 4062

cats and dogs mint



IC 3066

ABC friends pink



IC 4066

ABC friends blue



# BACKPACK KIDS



└ 21 x 28 x 12 cm  
□ 5 l

VE/UNIT 2/6

### • Der ideale Rucksack für kleine Weltenbummler!

- Geräumiges Hauptfach plus Trinkflaschenfach außen
- Ergonomische, gepolsterte, verstellbare Gurte
- Rückenpolsterung als Sitzmatte nutzbar
- panda/tiger: mit hochwertiger Bestickung
- cats and dogs/ABC friends: reflektierende Elemente für bessere Sichtbarkeit
- Namensschild innen
- Material: hochwertiges, reißfestes Polyestergewebe, wasserabweisend
- Recyceltes Obermaterial: 100% hochwertiges recyceltes Polyestergewebe, wasserabweisend

### • The perfect rucksack for globetrotting kids!

- Spacious main compartment plus exterior drinking bottle compartment
- Ergonomic padded adjustable straps
- Back padding doubles as seat pad
- panda/tiger: with premium embroidery
- cats and dogs/ABC friends: reflective elements for better visibility
- Name tag inside
- Material: premium-quality, tear-proof polyester, water-repellent
- Recycled outer material: 100% premium-quality recycled polyester, water-repellent

### • Le sac à dos idéal pour les petits globe-trotters !

- Vaste compartiment principal avec, en plus, une poche extérieure pour glisser sa boisson
- Sangles ergonomiques matelassées et réglables
- Le matelassage du dos peut être utilisé comme coussin
- panda/tiger : avec une broderie de haute qualité
- cats and dogs/ABC friends : éléments réfléchissants
- Porte-nom à l'intérieur
- Matière : polyester de haute qualité, indéchirable et déperlant
- Matière principale recyclée : 100% polyester recyclée de haute qualité, déperlant



IE 3072

panda dots pink



IE 4077

tiger navy



IE 3064

cats and dogs rose



IE 4062

cats and dogs mint



IE 3066

ABC friends pink



IE 4066

ABC friends blue

# TOILETBAG S KIDS



└ 18,5 x 16 x 7 cm  
(18,5 x 43 x 7 cm)

□ 1,5 l

VE/UNIT 4/36

• **Der Kinder-Kulturbeutel für alle Reisen und zu Hause**

- Hauptfach aus Netzmaterial mit 3 Steckschlaufen, 1 Reißverschlusstasche, Steckfach und Gummischlaufe
- Aufhängen und fertig!
- Plus: Namensschild innen
- Material: hochwertiges, reißfestes Polyestergewebe, wasserabweisend

• **Children's toiletry bag for holidays and home**

- Main mesh compartment with 3 holders, 1 zip pocket, compartment and elastic holder
- Hang it up and go!
- Plus: name tag inside
- Material: premium-quality, tear-proof polyester, water-repellent

• **Trousse de toilette pour enfants, à utiliser chez soi ou en voyage**

- D'une contenance insoupçonnée avec son compartiment principal en filet, 3 compartiments additionnels, 1 poche zippée et une boucle caoutchoutée pour la suspendre
- S'accroche tout simplement à l'endroit souhaité!

Le petit plus : porte-nom à l'intérieur  
• Matière : polyester de haute qualité, indéchirable et déperlant



IO 3064

cats and dogs rose



IO 4062

cats and dogs mint



IO 3066

ABC friends pink



IO 4066

ABC friends blue

# TOILETBAG KIDS



↳ 23 x 20 x 10 cm  
(23 x 55 x 10 cm)

□ 3 l

VE/UNIT 6/36

## • Der Kinder-Kulturbbeutel für alle Reisen und zu Hause

- Hauptfach aus Netzmaterial mit 3 Steckschlaufen, 1 Reißverschluss tasche, Steckfach und Gummischlaufe
- Aufhängen und fertig!
- cats and dogs: Spiegel innen
- panda/tiger: mit hochwertiger Bestickung und Namensschild innen
- Material: hochwertiges, reißfestes Polyestergewebe, wasserabweisend
- Recyceltes Obermaterial: 100 % hochwertiges recyceltes Polyestergewebe, wasserabweisend

## • Children's toiletry bag for holidays and home

- Main mesh compartment with 3 holders, 1 zip pocket, compartment and elastic holder
- Hang it up and go!
- cats and dogs: mirror inside
- panda/tiger: with premium embroidery and name tag inside
- Material: premium-quality, tear-proof polyester, water-repellent
- Recycled outer material: 100 % premium-quality recycled polyester, water-repellent

## • Trousse de toilette pour enfants, à utiliser chez soi ou en voyage

- D'une contenance insoupçonnée avec son compartiment principal en filet, 3 compartiments additionnels, une poche zippée et une boucle caoutchoutée pour la suspendre
- S'accroche tout simplement à l'endroit souhaité !
- cats and dogs : Le petit plus : miroir à l'intérieur
- panda/tiger : avec une broderie de haute qualité et porte-nom à l'intérieur
- Matière : polyester de haute qualité, indéchirable et déperlant
- Matière principale recyclée : 100 % polyester recyclée de haute qualité, déperlant



WH 3072

panda dots pink



WH 4077

tiger navy



WH 3064

cats and dogs rose



WH 4062

cats and dogs mint

# ALLROUNDER XS KIDS



↳ 27 x 21 x 12 cm

□ 5 l

VE/UNIT 4/24

#### • XS-Liebling to go

- Stauraum und 3 Innentaschen für den perfekten Überblick
- Große, praktische Öffnung mit Reißverschluss
- panda/tiger: mit hochwertiger Bestickung
- cats and dogs: reflektierende Elemente für bessere Sichtbarkeit bei Dunkelheit und schlechtem Wetter
- Voll bequem! Extraweiche Tragehenkel plus Tragegurt
- Material: hochwertiges, reißfestes Polyestergewebe, wasserabweisend
- Recyceltes Obermaterial: 100 % hochwertiges recyceltes Polyestergewebe, wasserabweisend

#### • XS darling to go

- Storage space and 3 inside pockets for a perfect overview
- Large and practical zip opening
- panda/tiger: with premium embroidery
- cats and dogs: reflective elements for better visibility in the dark and in bad weather
- Super comfy! Extra-soft carrying handle plus strap
- Material: high-quality, tear-proof polyester, water-repellent
- Recycled outer material: 100 % premium-quality recycled polyester, water-repellent

#### • L'allrounder préféré à emporter

- Espace de rangement avec 3 poches intérieures pour une parfaite organisation
- Grande ouverture pratique avec fermeture zippée
- panda/tiger : avec une broderie de haute qualité
- cats and dogs : éléments réfléchissants pour une meilleure visibilité dans l'obscurité et par mauvais temps
- Super confortable ! Poignées et bandoulière extra douces
- Matière : polyester de haute qualité, indéchirable et déperlant
- Matière principale recyclée : 100 % polyester recyclée de haute qualité, déperlant



**IQ 3072**

panda dots pink



**IQ 4077**

tiger navy



**IQ 3064**

cats and dogs rose



**IQ 4062**

cats and dogs mint

# ALLROUNDER M KIDS

**BEST  
SELLER**

↳ 40 x 33,5 x 24 cm  
□ 18 l

VE/UNIT 2/12

• **Die Reisetasche für (fast) alle Gelegenheiten!**

- Jede Menge Stauraum und 6 Innensteckfächer für alle Lieblingssachen
- Große, praktische Öffnung mit Reißverschluss
- Leichte Polsterung an Wänden und Boden
- Voll bequem! 2 Tragehenkel und Tragegurt mit gepolsterter Schulterauflage
- Die rückseitige Stecklasche hält an allen Reisetrolley-Griffen
- Mit tierisch coolem Motiv auf der Außentasche
- panda/tiger: mit hochwertiger Bestickung
- ABC friends: reflektierende Elemente für bessere Sichtbarkeit
- Material: hochwertiges, reißfestes Polyestergewebe, wasserabweisend
- Recyceltes Obermaterial: 100 % hochwertiges recyceltes Polyestergewebe, wasserabweisend

• **The travel bag for (nearly) all occasions!**

- Plenty of space and 6 inside pockets for all of your favourite items
- Large and practical zip opening
- Light padding on sides and base
- Highly comfortable! 2 carrying straps and padded shoulder strap
- Rear strap for attaching to trolley suitcases
- With an incredibly cool motif on the outer pocket
- panda/tiger: with premium embroidery
- ABC friends: reflective elements
- Material: premium-quality, tear-proof polyester, water-repellent
- Recycled outer material: 100 % premium-quality recycled polyester, water-repellent

• **Le sac de voyage idéal pour (presque) toutes les occasions !**

- Un maximum de place avec 6 compartiments intérieurs pour ranger toutes ses affaires préférées
- Grande ouverture pratique avec fermeture zippée
- Léger rembourrage des parois et du fond
- Super confortable ! 2 anses et une bandoulière rembourrée avec renfort au niveau de l'épaule
- Languette au dos pour fixer le sac sur les poignées d'une valise à roulettes
- Motifs animaux sympathiques sur la poche extérieure
- panda/tiger : avec une broderie de haute qualité
- ABC friends : éléments réfléchissants
- Matière : polyester de haute qualité, indéchirable et déperlant
- Matière principale recyclée : 100 % polyester recyclée de haute qualité, déperlant



**IX 3072**

panda dots pink



**IX 4077**

tiger navy



**IX 3064**

cats and dogs rose



**IX 4062**

cats and dogs mint



**IX 3066**

ABC friends pink



**IX 4066**

ABC friends blue



# TROLLEY XS KIDS



↳ 29 x 43 x 18 cm  
□ 19 l

VE/UNIT 1/4

### • Der lässig-coole Trolley – zum Verreisen oder Spielen!

- Superstabil und mühelos bewegbar
- Für Kleine und Große: höhenverstellbarer Teleskopgriff
- 2 große Hauptfächer mit Spannungsgurt und Netzfach
- Namensschild
- panda/tiger: mit hochwertiger Bestickung
- cats and dogs/ABC friends: reflektierende Elemente für bessere Sichtbarkeit
- Belastbar bis 12 kg
- Maximale Griffhöhe: 75 cm
- Material: hochwertiges, reißfestes Polyestergewebe, wasserabweisend
- Recyceltes Obermaterial: 100 % hochwertiges recyceltes Polyestergewebe, wasserabweisend

### • The casual-cool trolley suitcase – for travel or play!

- Ultra-stable, ultra-mobile
- Suits all heights: height-adjustable telescopic handle
- 2 large main compartments with elastic straps and net pocket
- Name tag
- panda/tiger: with premium embroidery
- cats and dogs/ABC friends: reflective elements
- Loadable up to 12 kg
- Maximum handle height: 75 cm
- Material: premium-quality, tear-proof polyester, water-repellent
- Recycled outer material: 100 % premium-quality recycled polyester, water-repellent

### • Un sac à roulettes incroyablement cool, que ce soit pour jouer ou pour voyager !

- Hyper stable, il se déplace sans effort
- Pour petits et grands : poignée télescopique, hauteur réglable
- D'une contenance insoupçonnée avec ses 2 grands compartiments principaux munis de sangles et son compartiment en filet
- Porte-nom
- panda/tiger : avec une broderie de haute qualité
- cats and dogs/ABC friends : éléments réfléchissants pour une meilleure visibilité
- Résistant jusqu'à 12 kg
- Hauteur maximale de la poignée : 75 cm
- Matière : polyester de haute qualité, indéchirable et déperlant
- Matière principale recyclée : 100 % polyester recyclée de haute qualité, déperlant



IL 3072

panda dots pink



IL 4077

tiger navy



IL 3064

cats and dogs rose



IL 4062

cats and dogs mint



IL 3066

ABC friends pink



IL 4066

ABC friends blue

KIDS

# BABYCASE



↳ 24 X 15,5 x 10 cm  
☐ 3 l  
🧺 machine wash cold

VE/UNIT 6/36

• **Unser Wickelcase: alles aufgeräumt und schnell zur Hand – für gut organisierte Eltern**

- 2 separate Taschen für Cremes, Schnuller und andere Kleinigkeiten
- Gummizug innen zum Verstauen von Feuchttüchern
- Großes Einsteckfach für Windeln
- Separate Wickelunterlage
- Separater Beutel mit Kordelzug zum Aufbewahren von Schmutzwäsche
- Material: hochwertiges Polyester-gewebe, wasserabweisend

• **Our diaper case: everything cleared away and ready to hand – for well-organised parents**

- 2 separate pockets for creams, pacifiers and other odds and ends
- Interior elastic band for storing baby wipes
- Large pocket for nappies
- Separate changing pad
- Separate drawstring pouch for storing dirty clothes
- Material: premium-quality, tear-proof polyester, water-repellent

• **Notre sac à langer : tout est rangé et à portée de main – pour les parents bien organisés**

- 2 poches séparées pour les crèmes, la tétine et autres petites affaires
- Bande élastique à l'intérieur pour ranger les lingettes
- Grande poche de rangement pour les couches
- Tapis à langer séparé
- Sac avec cordelette séparé pour ranger le linge sale
- Matière : polyester de haute qualité, déperlant



IR 7052

twist silver



# BABY ORGANIZER



└ 50 x 30 x 20 cm  
□ 15 l

VE/UNIT 2/12

#### • Multifunktionale Wickeltasche

- Kinderwagenbefestigung
- Große Öffnung mit Reißverschluss und gepolsterter Boden
- 2 Trageriemen
- Abnehmbarer, längenverstellbarer Schultergurt
- 4 Seitentaschen außen, 6 Steckfächer innen
- Gepolsterte Wickelunterlage, Beutel mit Kordelzug für Wäsche, isolierter Flaschenhalter mit Klett (Maschinenwäsche kalt)
- Material: hochwertiges Polyester-gewebe, wasserabweisend

#### • Multifunctional diaper bag

- Features attachments for stroller
- Large zip opening and padded base
- 2 carrying handles
- Detachable shoulder strap with adjustable length
- 4 pockets on the outside, 6 compartments on the inside
- Padded changing mat, pouch with drawstring for laundry, insulated bottle holder with Velcro fastener (machine wash cold)
- Material: premium-quality polyester, water-repellent

#### • Sac à langer multifonction

- Fixation pour poussette
- Grande ouverture zippée et fond rembourré
- 2 poignées
- Bandoulière amovible et réglable en longueur
- 4 poches latérales extérieures, 6 compartiments intérieurs
- Tapis à langer rembourré, sac avec cordelette pour le linge, porte-biberon isotherme avec velcro (lavage à froid en machine)
- Matière : polyester de haute qualité, déperlant



JB 7052

twist silver

# WARDROBE



DW 1017

wardrobe

↳ 31 x 72 x 31 cm

VE/UNIT 1/1

- wardrobe mit 8 Kleiderhaken
- Material: Metall, gebürstet

- wardrobe with 8 coat hooks
- Material: brushed metal

- wardrobe avec 8 crochets à vêtements
- Matière : métal brossé

# WARDROBE UMBRELLA



**DX 1017**

wardrobe umbrella

↳ 31 x 72 x 31 cm

VE/UNIT 1/1

- wardrobe umbrella mit 4 Kleiderhaken und dreigeteiltem Schirmständer mit Abtropfschale

- Material: Metall, gebürstet

- wardrobe umbrella with 4 coat hooks and umbrella stand in 3 sections with drip tray

- Material: brushed metal

- wardrobe umbrella avec 4 crochets à vêtements et un porte-parapluies divisé en trois avec bac d'égouttement

- Matière : métal brossé

# REISENTHEL

# STICK-SERVICE

REISENTHEL EMBROIDERY | BRODERIE

Individuell personalisierte Produkte sind ein Megatrend, denn durch ein persönliches Wort, einen Namen oder ein Logo wird jedes Produkt zu etwas ganz Besonderem. reisen-thel bringt Sie Ihrer Zielgruppe näher: mit unserem Stick-Service, mit dem Sie und Ihr Kunde ein einzigartiges Lieblingsstück kreieren und über das B2B-Portal bestellen können. Mehr Informationen dazu erhalten Sie von Ihrem Reisen-thel Ansprechpartner.

*Individually personalised products are bang on trend because a personal word, name or logo turns every product into something very special. reisen-thel brings you closer to your target group: with our embroidery service, with which you and your customer can create a unique favourite item and order it via the B2B portal. You can get more information about this from your inside sales representative.*

*Les produits personnalisés sont partout à la mode, car un petit mot personnel, un nom ou un logo rendent chaque produit très spécial. reisen-thel vous rapproche de votre groupe cible : notre service de broderie vous permet, à vous et à votre client, de créer votre objet favori unique et de le commander via le portail B2B. Vous obtiendrez plus d'informations à ce sujet auprès de votre collaborateur du service interne.*



**Einzigartige Lieblingsstücke, schnell und einfach personalisiert**

*Unique favourites personalised quickly and easily*

*Des pièces uniques, personnalisées rapidement et en toute simplicité*



**Tolle Geschenkidee**

*A fantastic gift idea | Une excellente idée de cadeau*



**Pro Bestickung nur 8,95 €\***

*Only €8.95\* per embroidery | Seulement 8,95 €\* par broderie*

**[b2b.reisen-thel.com/stick-service](https://b2b.reisen-thel.com/stick-service)**



**Bestickbare Produkte\*\* | Embroidery\*\* | Broderie\*\*:**

carrybag	allrounder S pocket	babycase
shoulderbag S	allrounder M	baby organizer
shopper M	allrounder L	
shopper XL	allrounder L pocket	
shopper e1	activitybag	rhombus carrybag
shoppingbasket	overnighter	rhombus classic shopper L
rolltop backpack	overnighter plus	rhombus classic shopper XL
allday backpack M	overnighter backpack M	rhombus shopper-backpack
allrounder R	netbookbag	rhombus duffelbag M
allrounder cross	workbag	rhombus notebook sleeve

\* UVP – unverbindliche Preisempfehlung. | \*\* Platzierung der Bestickung und maximale Zeichenzahl sind vorgegeben.

\* RRP – recommended retail price | \*\* Placement of embroidery and maximum number of characters are specified

\* PVC – prix de vente conseillé | \*\* L'emplacement de la broderie et le nombre maximum de caractères sont prédéfinis



# PRESENT YOUR BRAND TO THE WORLD!

Unverwechselbar, sympathisch und geniales Design mit Style: Durch zahlreiche Produkt-Ikonen ist reisenhel international als hochwertige Marke etabliert. Ob als Corporate Incentive oder als Give-away für Ihre B2B-Kommunikation bzw. Kundenbindung – eröffnen Sie Ihrer Marke neue Welten mit Ihrem Logo auf unseren reisenhel Business-, Travel- oder Shopping-Produkten!

*Distinctive, likeable and ingenious design with style: thanks to numerous product icons, reisenhel has established itself internationally as a high-quality brand. Whether as a corporate incentive or as a giveaway for your B2B communication or customer loyalty, open up new worlds for your brand with your logo on our reisenhel business, travel and shopping products!*

*Grâce à ses nombreux produits phares uniques, sympathiques et dotés d'un design stylé, reisenhel s'est établie sur le marché international comme une marque de qualité. Que ce soit en tant qu'organisatrice d'événements incentive ou de giveaway pour votre communication B2B ou la fidélisation de vos clients – ouvrez de nouveaux univers à votre marque en faisant apposer votre logo sur nos produits business, travel ou shopping reisenhel!*

## OUR BRANDING BESTSELLER

### MÖGLICHKEITEN DER INDIVIDUALISIERUNG:

- Transferdruck
- Siebdruck
- Stickerei
- Gravuren (Aluminiumteile)

### INDIVIDUALISATION OPTIONS:

- Transfer printing
- Silkscreen
- Embroidery
- Engraving (aluminium parts)

### POSSIBILITÉS DE PERSONNALISATION :

- Impression par transfert
- Sérigraphie
- Broderie
- Gravure (pièces en aluminium)

### SONDERPRODUKTIONEN:

- Weblabel
- Rubber-Patch
- Produkte in Ihrer eigenen Farbgestaltung

### SPECIAL PRODUCTIONS:

- Web label
- Rubber patch
- Products in your own colour design

### PRODUCTIONS SPÉCIALES :

- Logo cousu
- Écusson en caoutchouc
- Produits dans votre propre agencement de couleurs

### CONTACT

#### GERMANY

Christian Krieger  
Tel. +49 8105 77292-240  
Fax +49 8105 77292-920  
c.krieger@reisenhel.de

Claudia Parma  
Tel. +49 8105 77292-242  
Fax +49 8105 77292-920  
c.parma@reisenhel.de

#### GERMANY AND INTERNATIONAL

Valérie Völk  
Tel. +49 8105 77292-241  
Fax +49 8105 77292-920  
v.voelk@reisenhel.de

# DIE NEUEN REISENTHEL DISPLAYS

Moderne Optik, clevere Features und umweltfreundlicher Background – unsere neuen Displays haben das, was auch unsere Taschen und Accessoires haben: Sie sind stilvoll gestaltet mit natürlichen Holzelementen und viel Weiß und bieten absolute Flexibilität beim Bestücken. Produkt und Display ergänzen sich einfach perfekt. Die Verkaufsfläche wird zum Blickfang – und für den Händler zur Spielwiese.

## *The new reisenhel displays*

*With a modern look, clever features and environmentally friendly background, our new displays have what our bags and accessories have: stylish design with natural wooden elements and lots of white, and they offer absolute flexibility when it comes to fitting. Product and display simply complement each other perfectly. The sales floor becomes an eye-catcher – and a playground for the retailer.*

## *Les nouveaux présentoirs reisenhel*

*Un look moderne, des caractéristiques intelligentes et une origine écologique – nos nouveaux présentoirs offrent les mêmes avantages que nos sacs et accessoires : Ils sont conçus avec style à partir d'éléments naturels en bois et de beaucoup de blanc, et offrent une flexibilité absolue pour la mise en rayon. Le produit et le présentoir se complètent tout simplement à la perfection. La surface de vente devient un point de mire – et pour le commerçant, un terrain de jeu.*



**MORE  
DETAILS  
IN OUR  
DISPLAY  
CATALOGUE!**





10 M<sup>2</sup> FLÄCHE | 10 M<sup>2</sup> AREA

## IMPRINT

Der Inhalt des Katalogs unterliegt dem Urheberrecht der Firma Reisenthel Accessoires. Die Ausstellung, Vervielfältigung und Verbreitung der Bilder und Texte in der Öffentlichkeit ohne vorherige ausdrückliche schriftliche Genehmigung der Firma Reisenthel Accessoires ist verboten. Bei unberechtigter Nutzung der urheberrechtlich geschützten Werke kann die Firma Reisenthel Accessoires den Verletzer auf Unterlassung, Beseitigung der Beeinträchtigung und, wenn ihm Vorsatz oder Fahrlässigkeit zur Last fällt, auch auf Schadenersatz in Anspruch nehmen.

*The contents of the brochure are subject to the copyright laws of the company Reisenthel Accessoires. It is forbidden to exhibit, reproduce or distribute the images and texts for public use or access without obtaining the express prior written permission of Reisenthel Accessoires. Reisenthel Accessoires is entitled to exercise its right to injunctive relief and to demand the elimination of any interference or impairment in the event of unauthorised use of the copyright material, and may also make a compensation claim for damages in the event that the violator is charged with intent or negligence.*

*Le contenu du catalogue est soumis aux droits d'auteur de la société Reisenthel Accessoires. L'exposition, la reproduction et la divulgation de photos et de textes sans l'autorisation préalable écrite de la société Reisenthel Accessoires sont interdites. En cas d'utilisation illégitime d'œuvres protégées par des droits d'auteur, la société Reisenthel Accessoires peut demander une injonction ou la réparation du préjudice et, si le contrevenant a agi par négligence ou avec préméditation, elle peut également lui demander des dommages et intérêts.*



Reisenstheil Accessoires GmbH & Co. KG  
Zeppelinstraße 4  
82205 Gilching | Germany  
Tel. +49 810577292-0  
Fax +49 810577292-920  
info@reisenstheil.com  
reisenstheil.com

Order now: [www.b2b.reisenstheil.com](http://www.b2b.reisenstheil.com)